



EN Tent installation instructions

TERMS OF WARRANTY

1. Das Company Ltd. located in 32-540 Trzebinia, ul. Przemysłowa 10 street, NIP 6772373649, REGON: 122795114, registered by the District Court for Kraków - Śródmieście in Kraków, XI Commercial Division of the National Court Register under the number 0000451571, with the share capital of 1 825 000 PLN (hereinafter referred as "Das Company") grants for sold goods the warranty under the conditions described below.
2. The warranty for goods sold by Das Company is given for a period of one year from the date of purchase of the goods by the purchaser and is only valid on the territory of Poland.
3. Das Company removes a possible physical defect of good in accordance with the provisions of this warranty, if VAT invoice or receipt for the goods is provided and there are no premises described in Section 9 below.
4. In order to carry out the rights stated in the warranty, the buyer should provide by him-/herself and at her/his own expense defective goods to Das Company headquarters, together with a proof of purchase (e.g. a copy of the invoice/receipt) of the goods covered by the warranty in its original packaging and with all the elements and accessories included with the product as well as a written description of the reported faults and their causes (warranty claim). Failure in fulfilling these requirements will result in rejecting a warranty claim.
5. Das Company commits itself to recognize the warranty claim within 14 days and notify, in writing, the purchaser about the acceptance or rejection of the warranty claim. If warranty claim is accepted, you will be informed about the actions planned to eliminate product defects and date by which the defect is to be removed. If claim will be rejected, the customer will be informed about the cause of rejection and the product will be returned to the buyer and at his/her expense.
6. If the defect will be a result of the absence of elements, which should be included in the product, Das Company will send, at its own cost, missing element(s) of the product within 30 days after receiving warranty claim. Das Company will install and mount the missing element only at the express request of the buyer in the warranty claim and if the buyer delivers the product with the warranty claim.
7. The color of tarpaulin elements may slightly vary; it is not a defect and it is not exchangeable on the basis of the guarantee.
8. If the defect is result of the fact that the product has no properties mentioned by Das Company, or if the product or its item are damaged, Das Company will fix it, at its own expense and on its own, within 30 days after receiving the warranty claim. Das Company has the right to extend this period to a maximum of 60 days from the date after receiving the warranty claim. Das Company will notify, in writing, the customer about extending the deadline to remove defects. After removing the defects, Das Company will send product to the buyer on its own and at its own expense. Repaired or replaced with faultless components of the product become the property of Das Company.
9. If removing defects is not possible, Das Company will replace the defective products with defects-free one at the dates indicated above.
10. This warranty is valid only for defects resulting from causes laying in the sold product and does not cover damage of the product occurred after the sale from other reasons, in particular, it does not apply if defects in the product arose as a result of:
 - a. the self-caused usage by the buyer, especially if the product has been used contrary to the instructions of usage provided by Das Company
 - b. if they are the consequence of normal usage and wearing of the goods or incorrect storage / transport by the buyer
 - c. mechanical, chemical or thermal damages
 - d. modifications, repairs, alterations or changes in the properties of the product made by the buyer
11. If the buyer is a consumer, exercising the terms of the warranty does not exclude, limit or suspend the ability to exercise warranty for defects of the goods. In relation to buyers who are entrepreneurs, according to the general conditions of contract available here http://dascompany.com/warunki_handlowe and <http://dascompany.com/regulamin>, statutory rights under the warranty for defects are excluded.
12. Das Company is not liable for damages resulting from inability to use the product send for repair, in particular, the buyer has no right to demand from Das Company claims for opportunity costs.
13. Das Company is not responsible for failure to observe the provisions of this warranty, in particular, failure to observe time limits specified in paragraphs 5-7, if they are the consequence of force majeure, the self-caused operation of the buyer or a third party, for which Das Company is not responsible or other circumstances unforeseen and independent on Das Company.
14. Das Company reserves the right to modify the terms of this warranty, however any changes in the warranty will not retroact.
15. Contact with guarantor: biuro@dascompany.com, phone: 500 248 480
16. The present warranty is valid from April 6-th, 2016



Terms of Use

1. In some countries you may need a building permit to assemble the tent.
2. The tent is only a temporary construction; it should not be used continuously.
3. The tent should be assembled in considerable distance from the pipelines, gas lines and electric wires.
4. Before the assembly, it should be made sure that the temperature outside is above 15 degrees Celsius. These conditions will prevent the cover from rupturing.
5. The tent should be assembled according to the manual.
6. The tent should be attached to the ground; all the holes in the feet should be used.
7. Only original parts should be used in the process of assembling the tent.
8. The tent should not be deployed during bad weather conditions, which include: a downpour, a strong wind or a snowfall.
9. In the case of any unfavourable weather conditions, the tent must be disassembled.
10. All the zippers must be fastened or opened entirely; it will prevent any damage to the cover. The zippers must not be half opened or half closed.
11. It should be made sure that the cover is strung accordingly. Such setting prevents water from gathering on the roof. Consequently, the tent will not be in danger of collapsing.
12. It should be noted that the water, if gathered on the roof, should be disposed of systematically.
13. During the winter, falling snow can be found gathering on the roof. It should be remembered that it must be kept off the tent; doing so prevents the tent from being damaged.
14. An adequate dilatation should be retained. It will allow gathered snow to fall off the tent.
15. The user of the tent is responsible for appropriate protection of the tent from any damage. The tent should be kept in such condition to prevent the users and the properties inside from any harm.
16. Open fire, the radiators with fire or the welding equipment should not be used in a proximity of the tent. Any other kinds of radiators can be used, but should not be put closer than a meter and a half from the cover.
17. The tent can be disassembled and packed only when it is dry; doing so prevents the formation of fungus.
18. The guarantee is valid only in the events which take place after the tent is assembled according to the manual and the terms of use.
19. The guarantee does not cover the wear of the consumables such as rubber or screws.
20. The guarantee does not cover the damage that is the result of negligence or incorrect use.
21. The tents with S38 (summer) and SP38 (summer plus) construction can be only used in the summer.
22. The tents using PE cover can be only used in the summer.
23. The tents with P50 (winter), PP50 (winter plus), polar and polar plus constructions can be also used in the winter.



















Terms of Trade



1. It is assumed that once the buyer (called The Customer) was given the invoice, they have been informed about Terms of Trade, they accepted it and agreed to comply.
2. The orders are realized in consideration with this Terms of Trade, written rules and agreements with the Customer. Additional objections, conditions and agreements differing from this Terms of Trade require to be enclosed in the written form and each must be accepted by the Agent.
3. When, according to the law, the Customer did not sign the invoice or the bill, it is assumed that they have read the Terms of Trade, accepted it and agreed them without any objections the moment when they were handed the invoice. The orders can be placed every working day in the company's headquarters, online on <http://dascompany.com> or via e-mail located on our website.
4. The order placed via Internet (the order form or the e-mail) binds the parties in the moment of placing of the order.
5. The cancellation of the order is only possible before the Agent's confirmation.

The cancellation of the order after the start of its processing is only possible if the Agent issues a written agreement. The cancellation of the order authorises the Agent to keep the advance when the processing of the order has started, especially when particular parts of construction has been ordered or a project of the ordered object has been prepared.

The ordered and delivered previously return can only be accepted if the Agent issues a written agreement. The Customer assesses themselves the suitability of the product or the service to their own needs.
6. The Agent is not responsible for the use of the product against the instructions of the Agent (the user's manual) or erroneous interpretation of information and specifications included in the offer, a project of the hall or conveyed to the Customer in any other way.
7. The prices shown in the Agent's advertisements or offers do not make an offer as understood in the regulations of the Civil Code.
8. The prices shown in the Agent's advertisements or offers are only indicative. The final price is a matter of agreement between the Agent and the Customer before the product is given, when the order is placed or the latest when the agreement is written.
9. Provided the price is not set, the Agent reserves the right to send an invoice and use the prices true on the day of the delivery of the supplies, taking into account actual price list, stock prices, tariff rates, tax rates and the currency rates according to the National Bank of Poland.
10. The object of the agreement is the possession of the Agent until the price is paid in full by the Customer and the delivery protocol is signed. The price is determined in the agreement.
11. The Customer's obligations are as follows:
 - Absolute compliance to the resolutions of General Terms & Conditions of Purchase,
 - Absolute compliance to the resolution of Guarantee Card,
 - The payment.
12. The dangers connected with the usage of the hall are passed to the Lessee. The Lessee is obliged to insure the object of the lease, including acquiring the liability insurance policy.
13. In the case when the product is being sent to the Customer via the Carrier, the benefits and burdens of the product and the danger of the accidental loss or damage of the product pass onto the Customer in the moment when the product is handed to the Carrier. If the Customer detects differences between the product they have been sent and the product stated in the bill of loading when the product is delivered to them, they should immediately enclose their objections on the Carrier's copy of bill of loading. These activities aim to determine the rules and the range of Carrier's responsibility. Failure to fulfill such obligation by the Customer will result in their resignation from their right to file a complaint on the physical defects of the product – if the product is damaged.
14. In the case when the Customer claims the product themselves, the benefits and burdens of the product and the danger of the accidental loss or damage of the product pass onto the Customer in the moment when the product is released from the warehouse of the Agent. Person who claims the product on behalf of the Customer should possess written letter of authority given by the person authorized to represent the Customer. The Customer or the person authorized is obliged to carefully examine the state of the product. It concerns especially the physical damage or visible flaws. After the product is claimed, the complaints concerning physical damage of the product or its packaging or other visible flaws will not be taken into consideration.
15. In the case when the Customer will not collect the product or refuses to receive it on the deadline, the Agent has the right to put the product in the warehouse at the expense of the Customer. If the delay in the collection from the Agent's warehouse takes longer than two weeks from the date when it became available for the Customer or the Customer refuses to collect the product, the Agent has the right to renounce the contract or sell the product at the expense and risk of the Customer.
16. If the Customer places the order according to the Ordinance of the Finance Minister from 17th of December 2010, Journal of Laws No. 249, Entry 1661, they accept the invoice for the products bought from Das Company Sp. z o.o. with the headquarters in Kraków sent via e-mail disclosed by the Customer in the order placement process.
17. If the payment due was not settled on the deadline, the Agent acquires the right to demand:
 - From the Customer to pay the interest equaling the current statutory interest rate,
 - From the Customer to immediately pay the remaining invoices with the later payment deadline,
 - From the Customer to pay the price before the date of product claim resulting from the fact that the Customer has other orders placed and they are already processing.

The parties can make an agreement on the terms of the settlement.
18. The Customer agrees to process their personal data for the purpose of execution of the order (as defined in the Act of August 29, 1997 on the Protection of Personal Data; Codification: Journal of Laws No. From 2002, no 101, item 926 with the changes.)
19. In the unsettled cases in this Terms of Trade and also in the respective agreements with the Customers, the regulations of the Civil Code shall apply.

Name	No.	Picture	4 x 6	Extra 2 m	Extra 1 m
Tube dia. 50 mm (Φ) (1890 mm)	1		12	2	2
Tube dia. 38 mm (Φ) (1920 mm)	2		21	7	
Tube dia. 38 mm (Φ) (930 mm)	3				7
Triple roof connector dia. 54 mm (Φ)	4		4		
Quad roof connector dia. 54 mm (Φ)	5		4	2	2
Corner foot	6		2		
Corner foot	7		2		
Foot	8		4	2	2
Entrance foot	9		4		
Roof bracing dia. 25 mm (Φ) (320 mm)	10		4	1	1
Peg 8x300 mm	11		4		
Peg 6x180 mm	12		12	2	2
Peg 4x180 mm	13		42	6	6
Rope	14		4		
Screw M6x35	15		9	2	2
Screw M8x50	16		50	10	10
Screw M8x70	17		62	12	12
Loop to mount the entrance	18		12		

Name	No.	List of additional parts	
Lifting tube: 0,5 m height	19		
Lifting tube: 1 m height	20		
Reinforcement	21		
Side cross cable, height: 2m	22		
Side cross cable, height: 2,5m	23		
Side cross cable, height: 3m	24		
Side cross cable, height: 3,5m	25		
Side cross cable, height: 4m	26		
horizontal pipe (2 m) for the FR cover	27		
horizontal pipe (2 m) for the FR cover	28		
horizontal pipe (1 m) for the FR cover	29		
Horizontal pipe inserted into FR cover (2 m)	30		
Horizontal pipe inserted into FR cover (1 m)	31		
Horizontal reinforcements for entrances width: 5m	57		
Horizontal reinforcements for entrances width: 6m	67		
Horizontal reinforcements for entrances width: 8m	87		
Roof cross cable for 4m width	48		
Roofs cross cable for 5m width	58		
Roofs cross cable for 6m width	68		
Roofs cross cable for 8m width	88		

STEP 1

The tent should be deployed on the flat surface.

For the tents with the even length of the side eg.: 8m, 10m, 12m, 20m, 30m,

Distribute the parts as pictured below. The connectors's **(5)** longer side should be facing the connector **(B3)**. Assemble all the tubes dia. 50 mm (Φ) **(2)** tubes with the connectors using the M8x70 screws. Tubes dia. 38 mm (Φ) **(41)** should be assembled with the M8x50 screws.

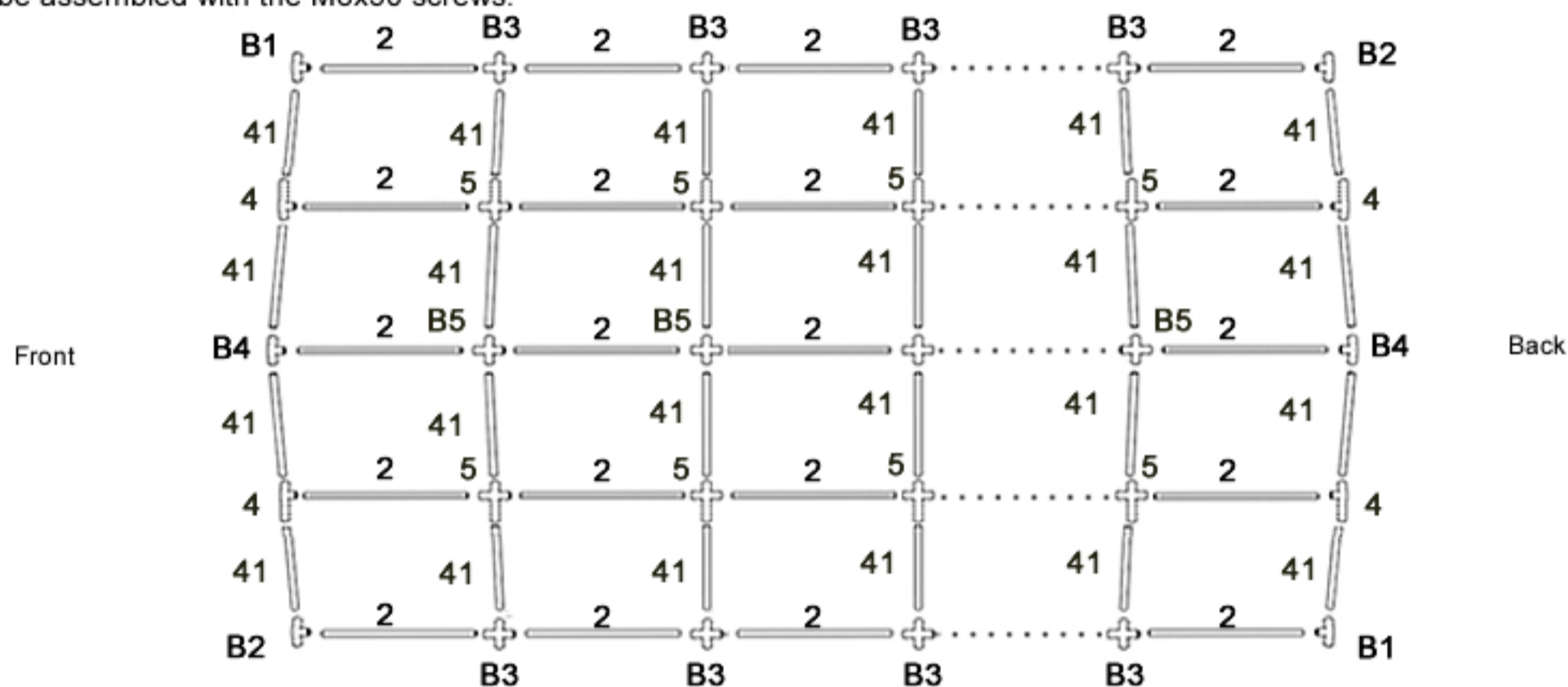

For the tents with the uneven length of the side eg.: 9m, 11m, 13m, 21m, 31m.....

Distribute the parts as pictured below. The connectors's **(5)** longer side should be facing the connector **(B3)**. Assemble all the dia. 50 mm (Φ) **(2)** tubes with the connectors using the M8x70 screws. Tubes dia. 38 mm (Φ) **(41)** should be assembled with the M8x50 screws .

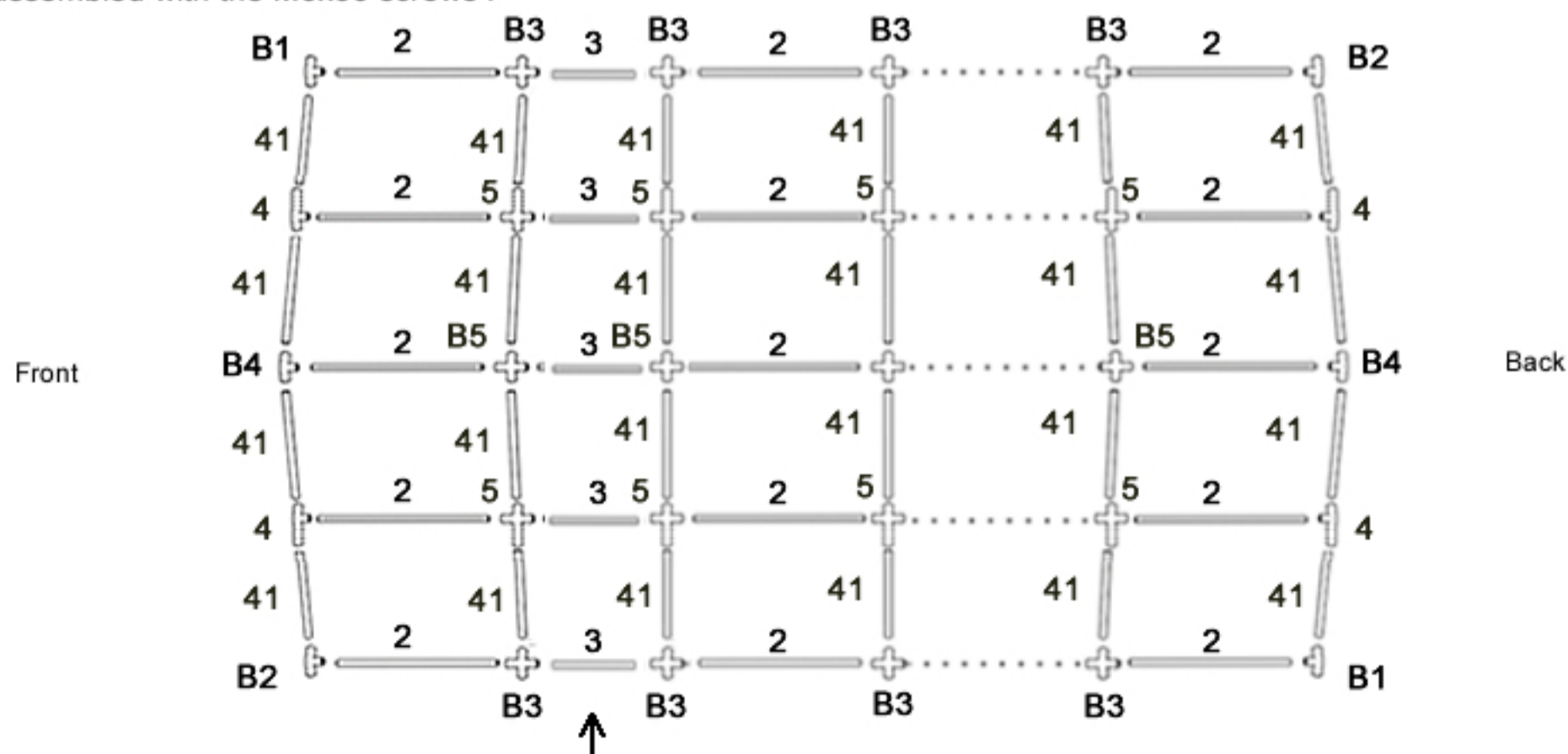

The extension tube should be located in the second section.

STEP 2/a

- 1** Assemble together the roof brackets (**B4**) and (**B5**) with the horizontal roof bracing (**10**) using the M6x35 screws.

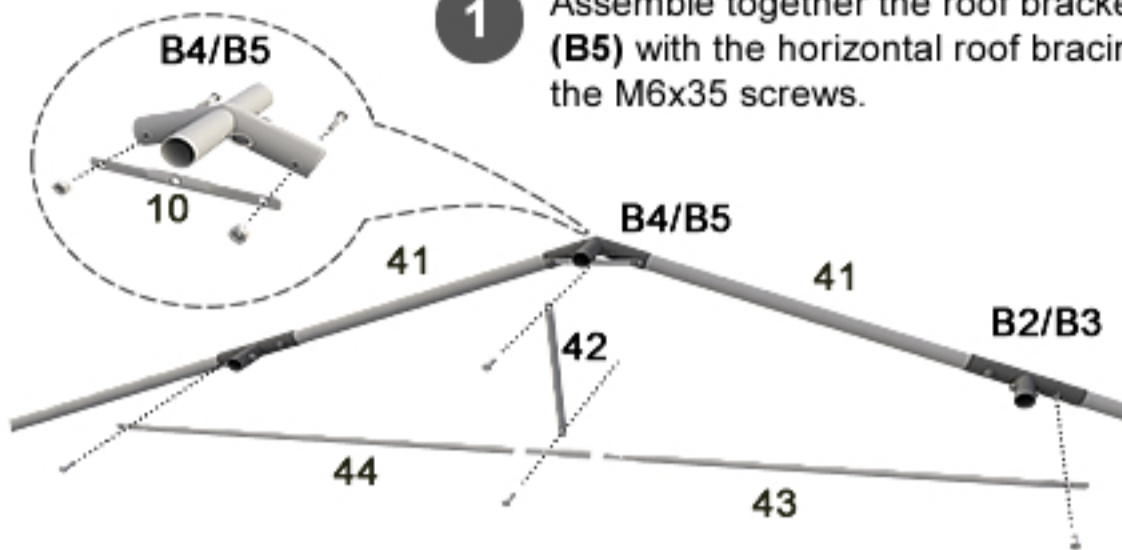

- 2** Assemble together horizontal bracings (**44**) and (**43**) using the M6x35 screws.

Connect the obtained construction to the lower part of the connectors (**B2** or **B3**). The middle of the assembled part connect with the horizontal bracing (**10**) using the vertical roof bracing (**42**).

- 3** Fully assembled roof structure should look like on the picture on the side.

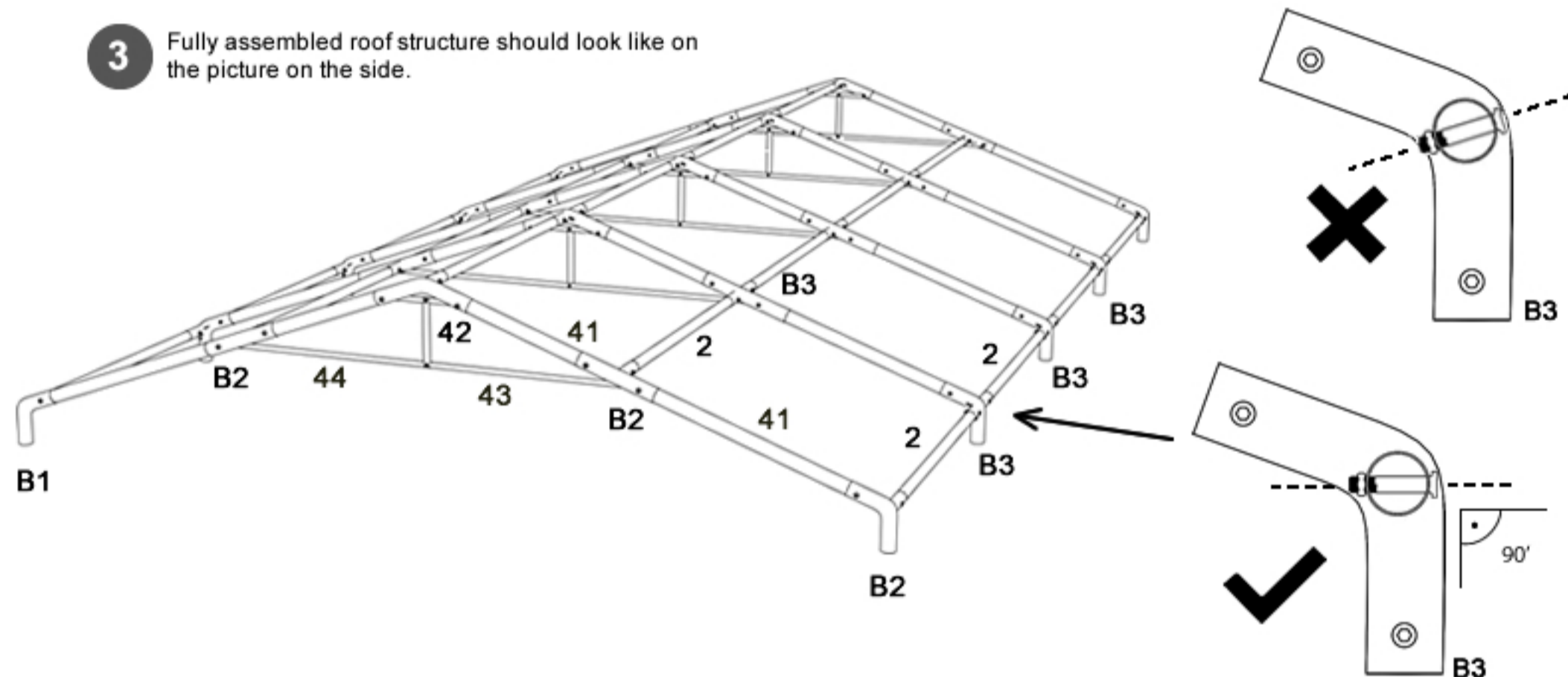

⚠ The tent with the roof pulls (optional)

On the both sides of the tent mount the cross cables (**48**) every two sections. The cables should cross in the middle. Start with the connector (**B4**) and (**B2**). Every roof cable should be fixed above the roof construction.

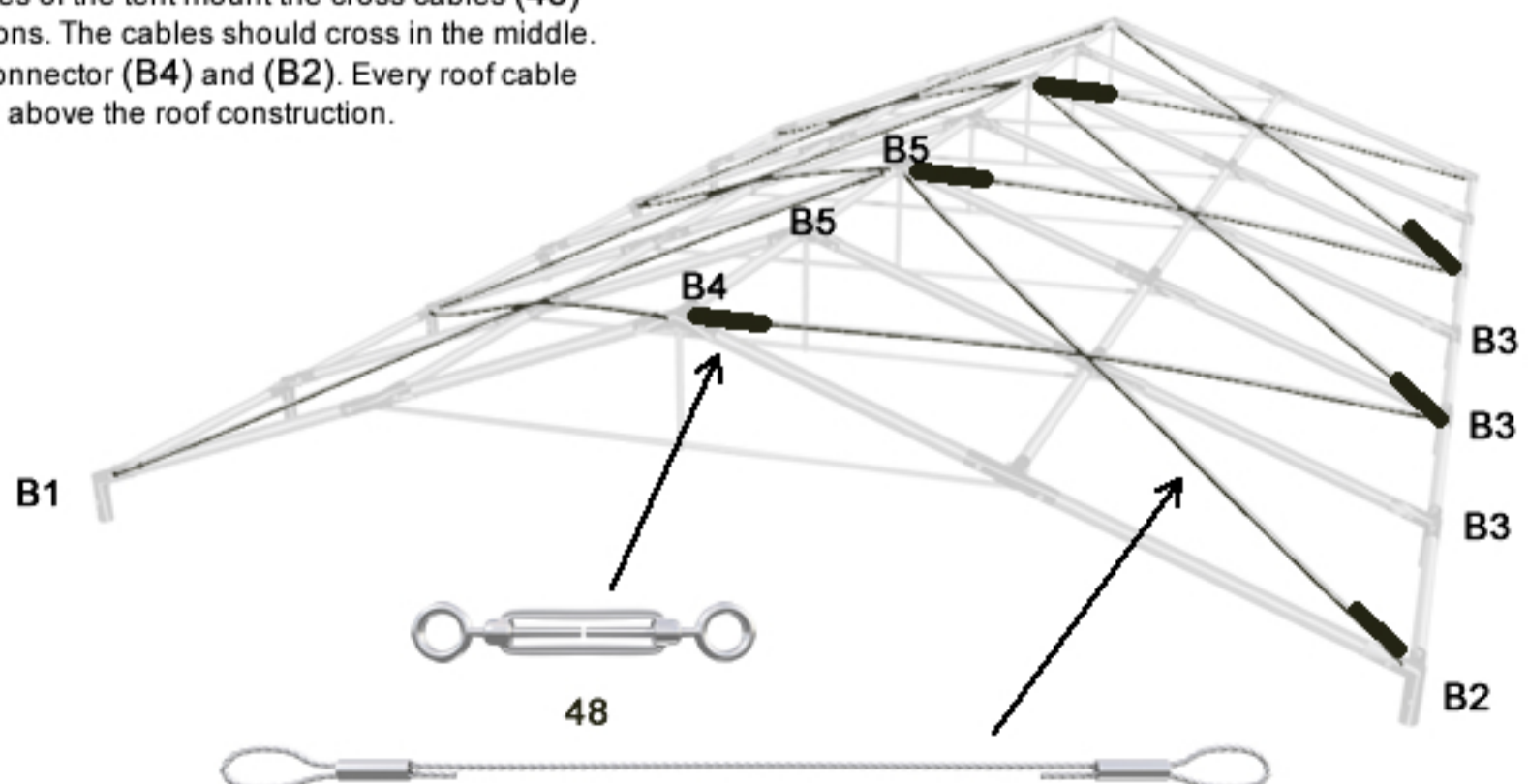

STEP 3

Table of parts for the heights:

Heights	Parts
2m	no. 1 (Picture no. 1)
2,5m	no. 1 + no.19 (Picture no. 2)
3m	no. 1 + no..20 (Picture no. 2)

Table of parts for the heights:

Heights	Parts
3,5m	no.1 + no.20 + no.19 (Picture no. 3)
4m	no.1 + no.20 + no.20 (Picture no. 3)

Gently lift the tent on one side and mount the tubes (1). The three symmetrical holes in the tube should be facing downwards. Next, lift the tent on the other side and repeat the action.

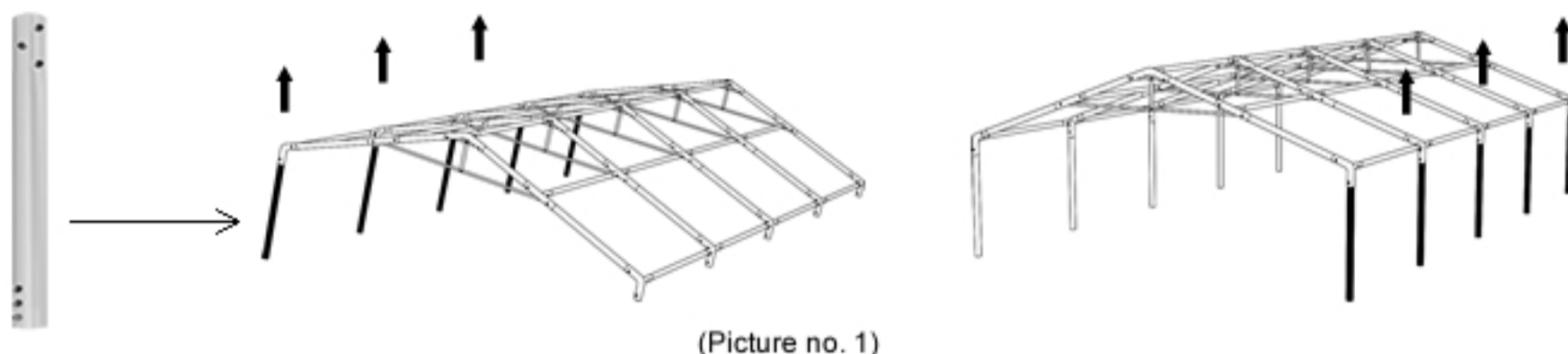

(Picture no. 1)

STEP 3/a ⚠ For the 2,5 or 3m height.

Lift the tent with the tubes installed on the one side and mount the 0,5 m lifting tubes (19) for the tent height 2,5m, or 1 m lifting tubes (20) for the tent 3 m height. Then, lift the tent on the other side and repeat the action.



(Picture no.2)

STEP 3/b ⚠ For the 3,5 or 4m height.

Lift the tent with the lifting tubes (19 or 20) installed on the one side; next, mount the 0,5 m lifting tubes (19) or 1 m lifting tubes (20). Then, lift the tent on the other side and repeat the action.

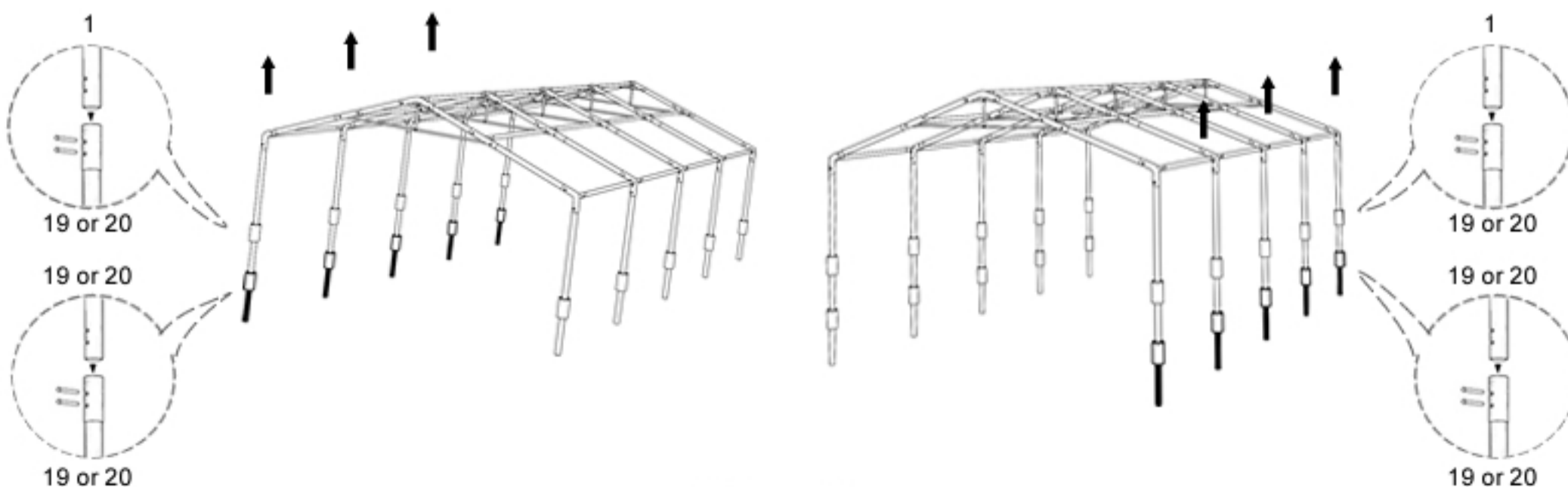

(Picture no. 3)

STEP 4

Mount diagonally the corner feet (6), and next the feet (7) to the construction of the tent. On the side of the construction mount feet (8) and connect them to the tubes (2). For the tents with the uneven side length, mount the extension in the third section. Next install the feet (9) on the back and the front; connect them with the corner feet using the tube (45). All the feet should be mounted securely to the ground.

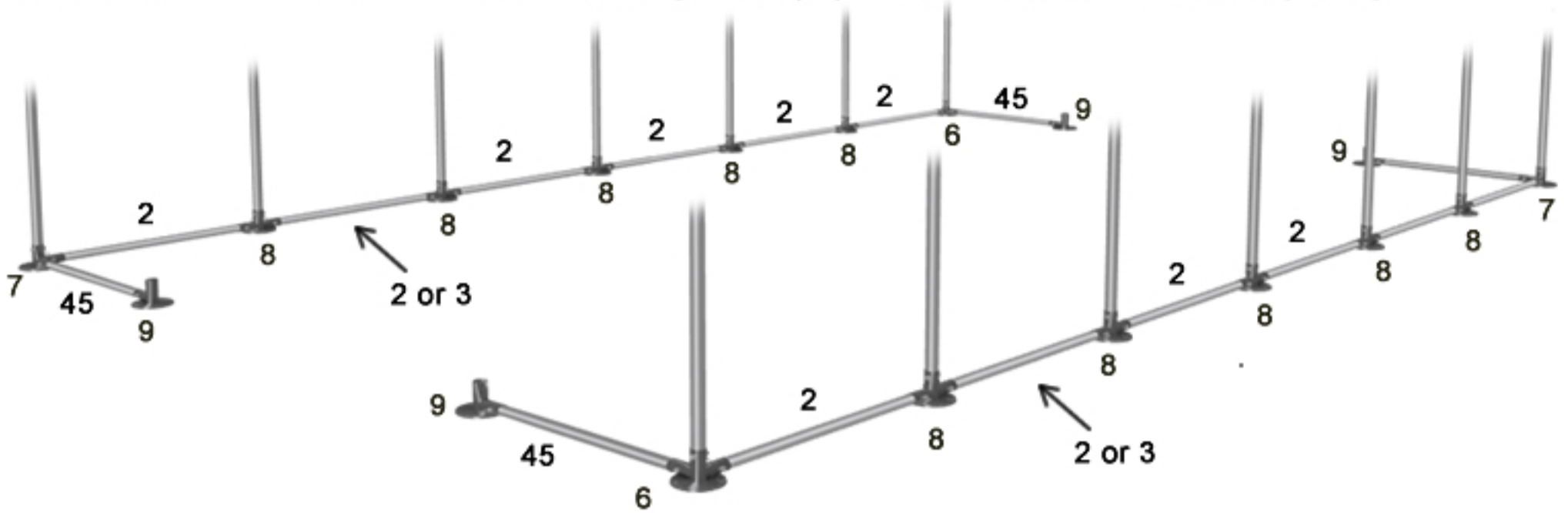

STEP 5

Connect the tubes (1) and (46). These elements should be mounted to the entrance feet (9) and the connector (4). The connection with the connectors (4) should be on the inside of the tent.

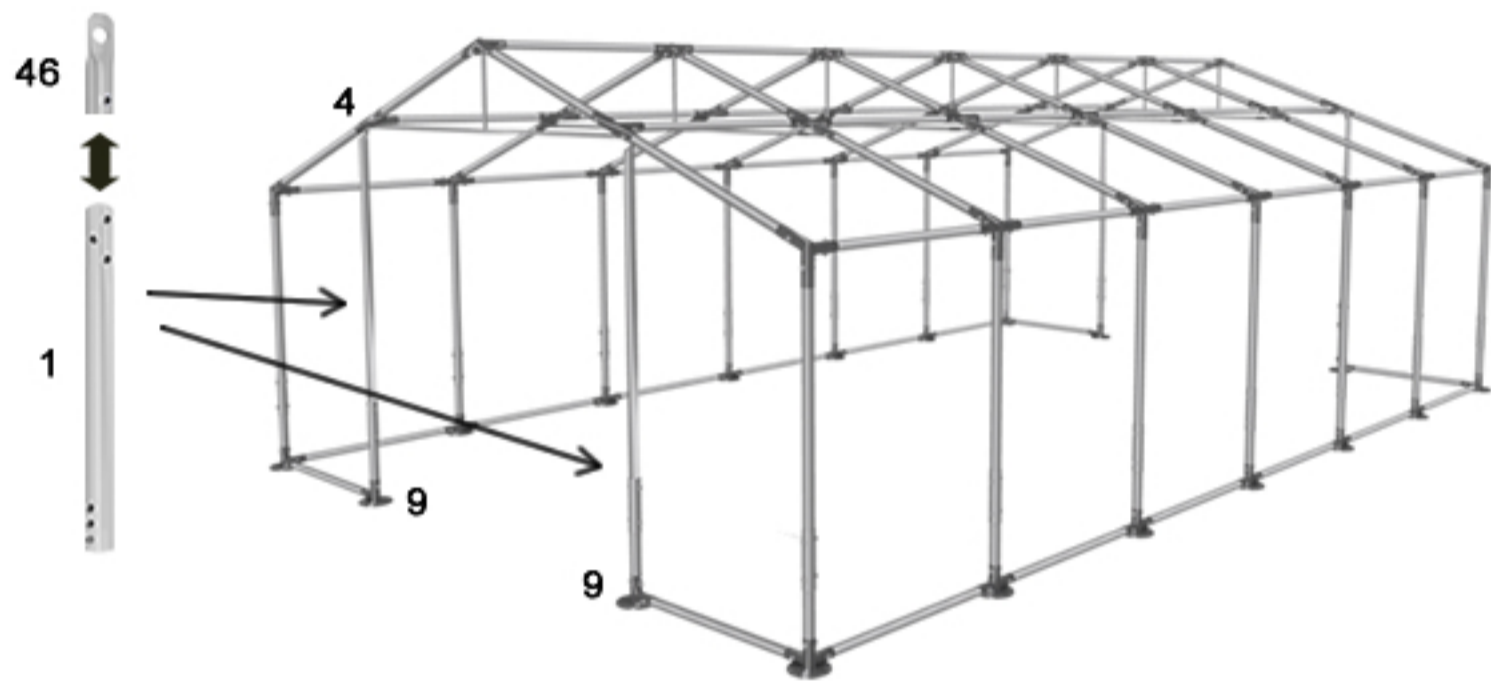

⚠ Tent with the side pulls. (optional)

On the both sides of the tent install the side pulls every two sections. The pulls should cross in the middle. Mount the pulls starting from the connector (B1) and feet (7). All the pulls should be mounted on the outer side of the construction.

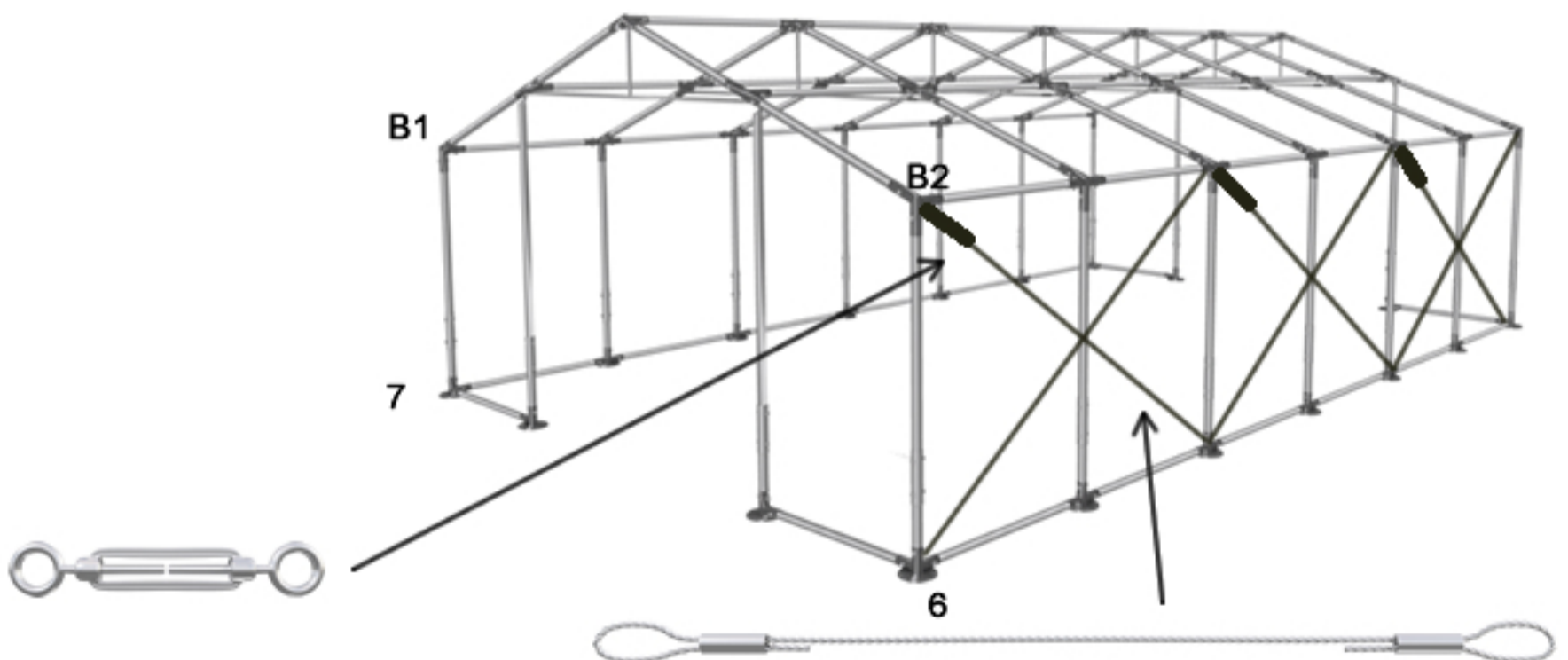

⚠ Tent with the single reinforcements - Polar (optional)

The reinforcement (21) should be connected to the vertical pipe (1) and roof pipe (41).

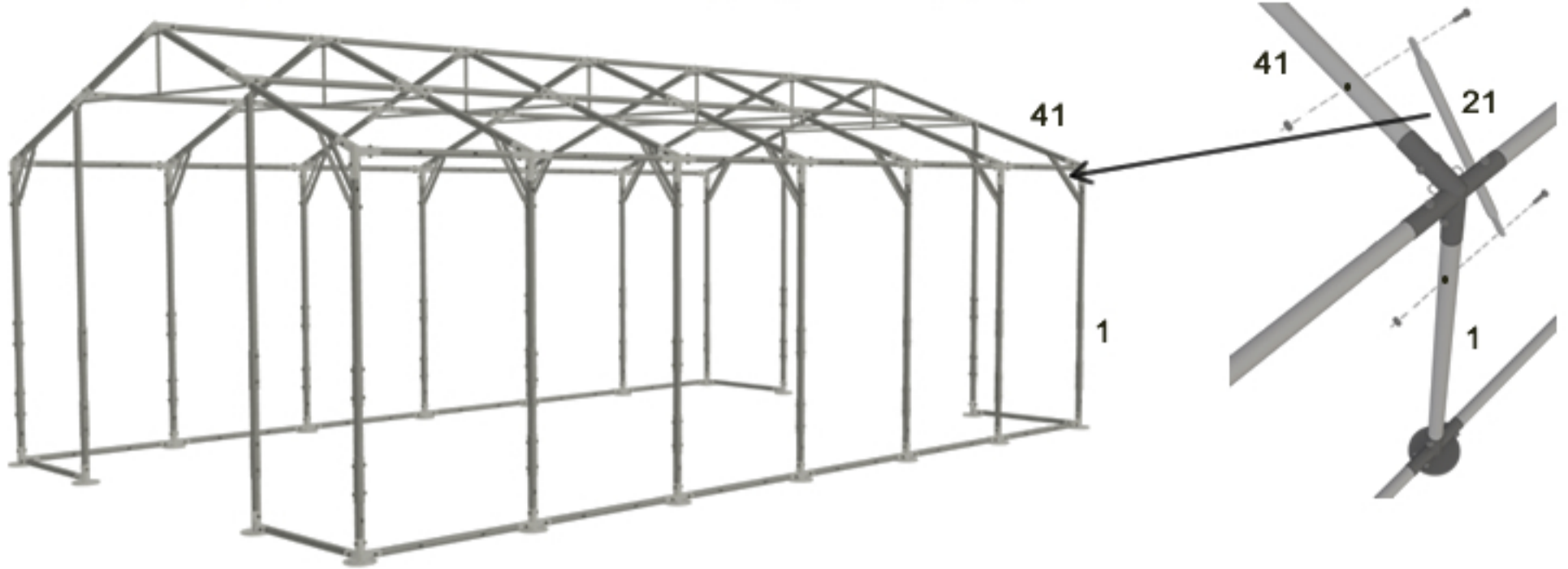

⚠ Tent with the double reinforcements - Polar Plus (optional)

Two reinforcements (21) should be connected to the vertical pipe (1) and roof pipe (41).

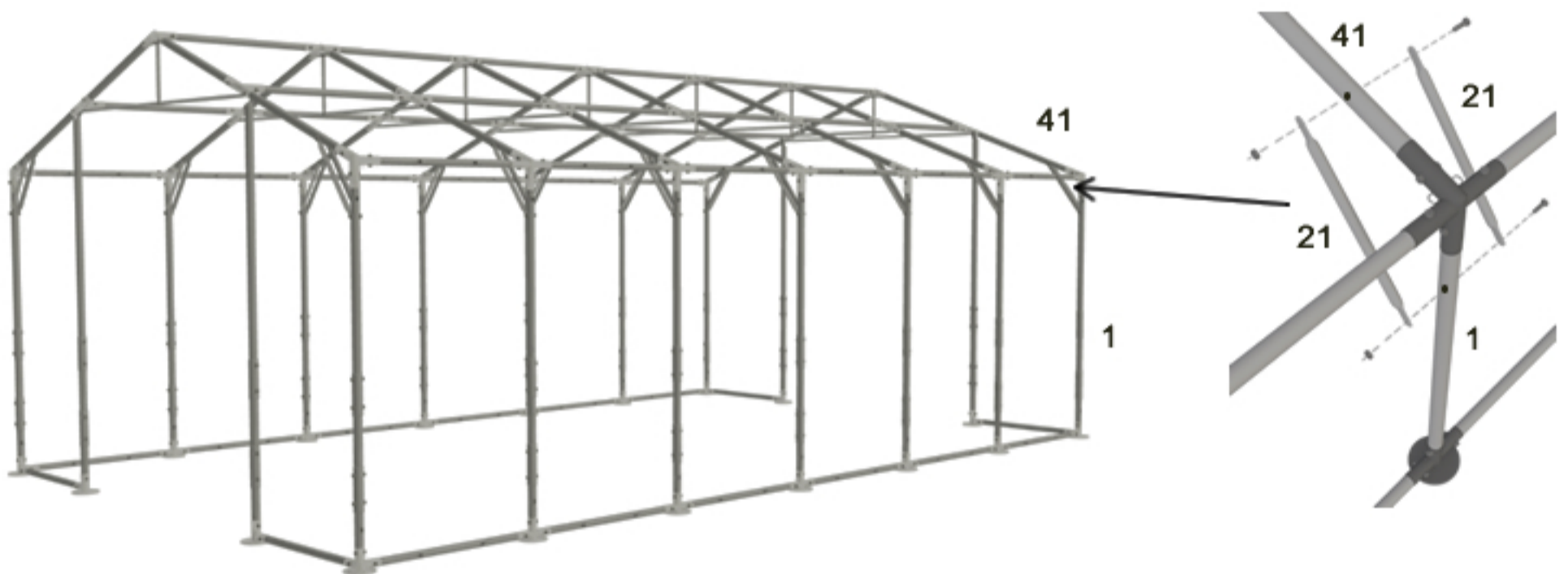

⚠ Tent with the single reinforcements - Polar (optional)

The side reinforcement (21) should be connected to the vertical tube (1) and horizontal tube (2).
The reinforcements should be placed on the inside of the tent.

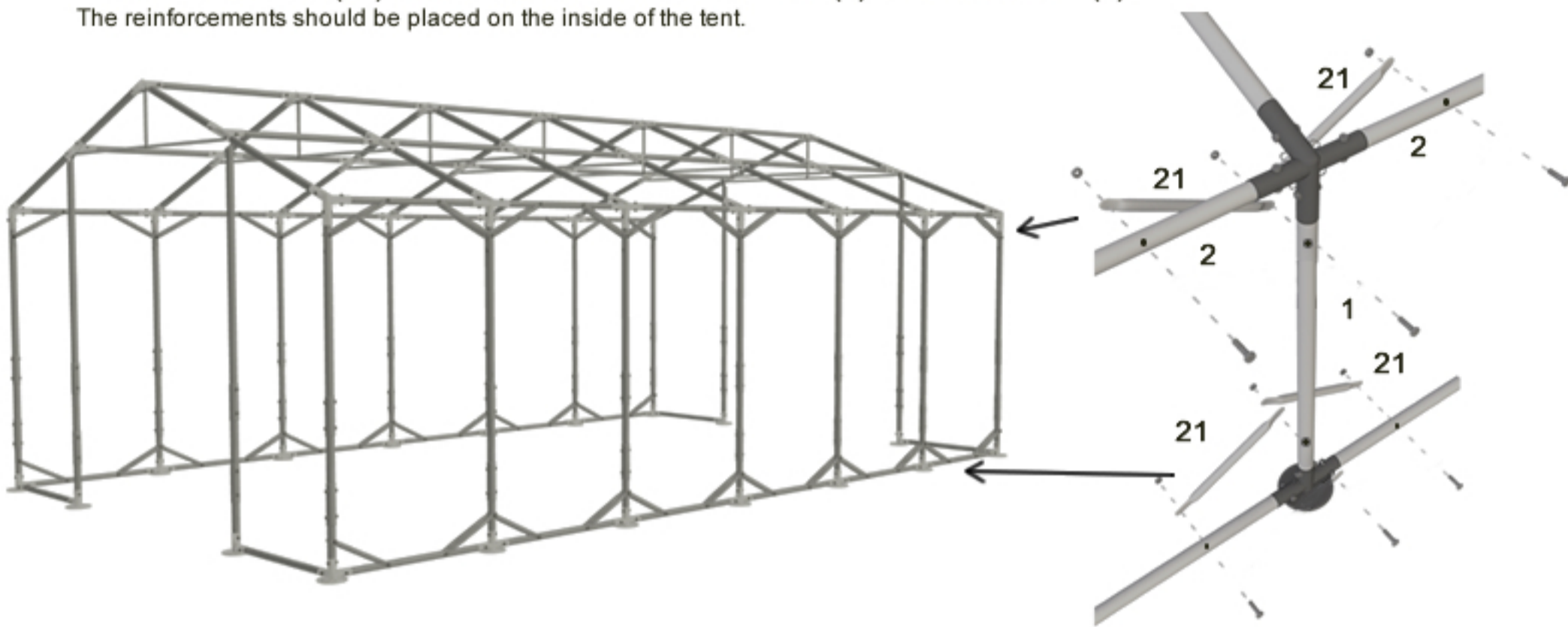

⚠ Tent with the double reinforcements - Polar Plus (optional)

Two reinforcements (21) should be connected to the vertical tube (1) and horizontal tube (2).
The reinforcements should be mounted on the either inside and outside sides of tubes (1) and (2).

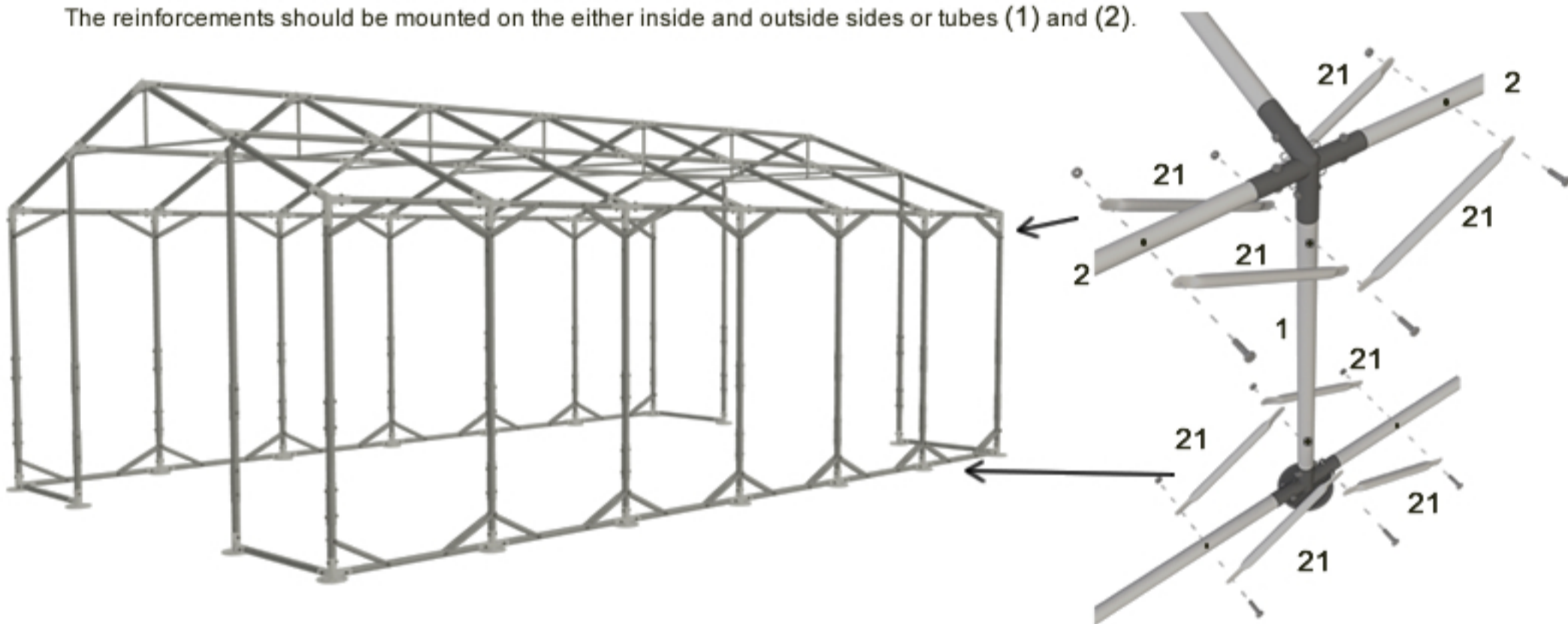

STEP 6

For the tents with the side panels height 2 m mount the panels with the drainage apron facing downwards.

For the tents with the side panels height above 2 m you need to connect the basic panel with the lifting panel(s).

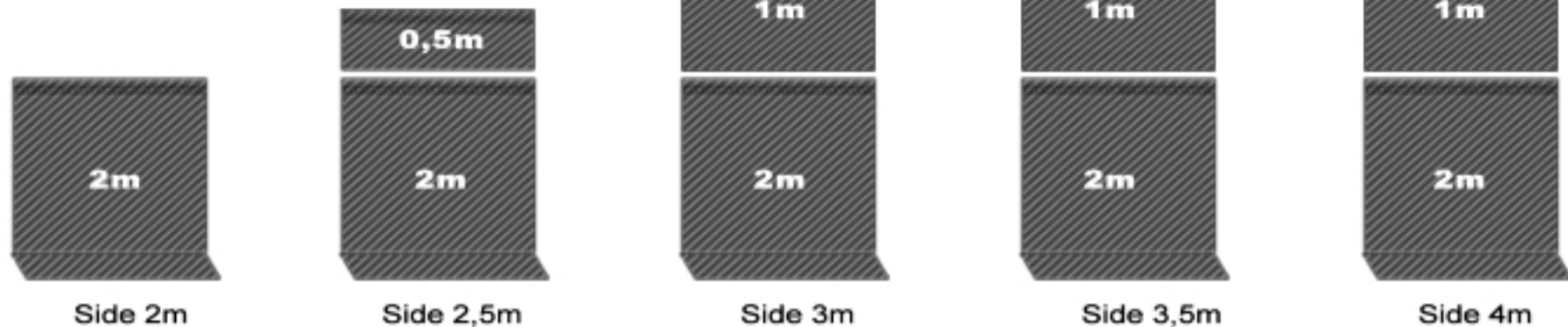

Assembled panels are ready to be mounted using the velcros on the roof. In order to fix the panels on the sides the elastic rubber with the ball should be used.

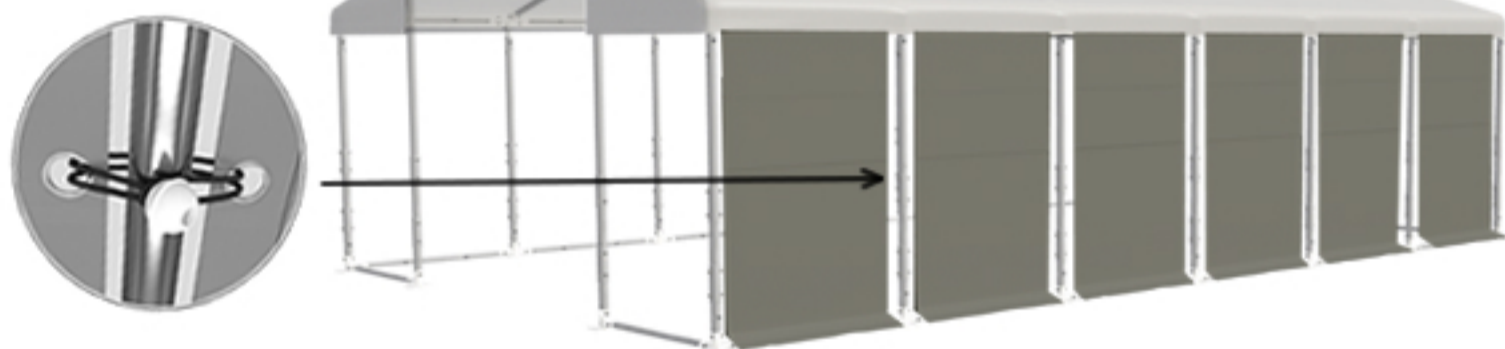

The metal loops and elastic rubber with ball are required to fix the entrance on the both sides of the tent. Install the top to the vertical tube (bracings 43 and 44 put together) using the metal loops. Fix the sides using the elastic rubbers with the balls.

Attach the masking stripes. If the tent's side panel's height is above 2 m, connect the masking stripes like the side panels (see the picture below). Four wider masking stripes should be fixed on the sides of the tent.

