

EN Tent installation instructions











TERMS OF WARRANTY

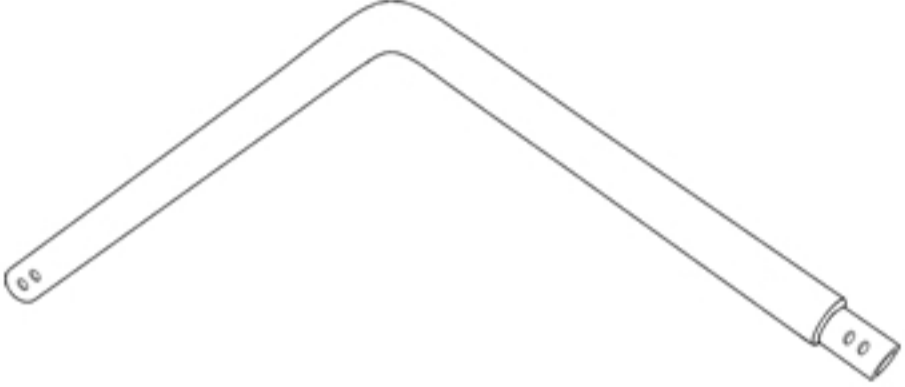
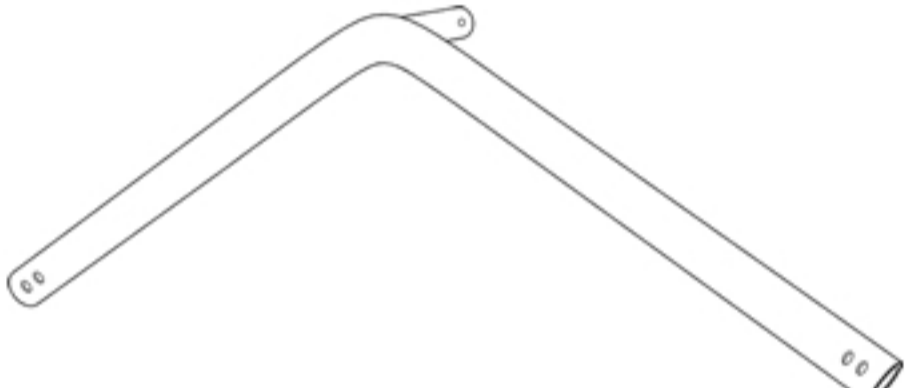
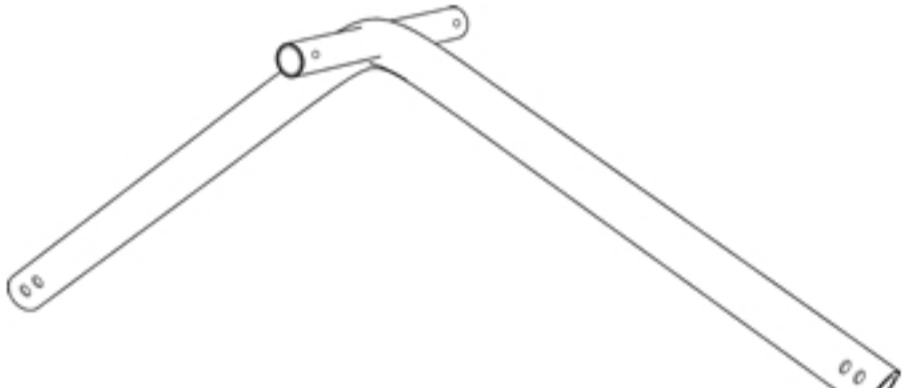











1. Das Company Ltd. located in 32-540 Trzebinia, ul. Przemysłowa 10 street, NIP 6772373649, REGON: 122795114, registered by the District Court for Kraków - Śródmieście in Kraków, XI Commercial Division of the National Court Register under the number 0000451571, with the share capital of 1 825 000 PLN (hereinafter referred as "Das Company") grants for sold goods the warranty under the conditions described below.
2. The warranty for goods sold by Das Company is given for a period of one year from the date of purchase of the goods by the purchaser and is only valid on the territory of Poland.
3. Das Company removes a possible physical defect of good in accordance with the provisions of this warranty, if VAT invoice or receipt for the goods is provided and there are no premises described in Section 9 below.
4. In order to carry out the rights stated in the warranty, the buyer should provide by him-/herself and at her/his own expense defective goods to Das Company headquarters, together with a proof of purchase (e.g. a copy of the invoice/receipt) of the goods covered by the warranty in its original packaging and with all the elements and accessories included with the product as well as a written description of the reported faults and their causes (warranty claim). Failure in fulfilling these requirements will result in rejecting a warranty claim.
5. Das Company commits itself to recognize the warranty claim within 14 days and notify, in writing, the purchaser about the acceptance or rejection of the warranty claim. If warranty claim is accepted, you will be informed about the actions planned to eliminate product defects and date by which the defect is to be removed. If claim will be rejected, the customer will be informed about the cause of rejection and the product will be returned to the buyer and at his/her expense.
6. If the defect will be a result of the absence of elements, which should be included in the product, Das Company will send, at its own cost, missing element(s) of the product within 30 days after receiving warranty claim. Das Company will install and mount the missing element only at the express request of the buyer in the warranty claim and if the buyer delivers the product with the warranty claim.
7. The color of tarpaulin elements may slightly vary; it is not a defect and it is not exchangeable on the basis of the guarantee.
8. If the defect is result of the fact that the product has no properties mentioned by Das Company, or if the product or its item are damaged, Das Company will fix it, at its own expense and on its own, within 30 days after receiving the warranty claim. Das Company has the right to extend this period to a maximum of 60 days from the date after receiving the warranty claim. Das Company will notify, in writing, the customer about extending the deadline to remove defects. After removing the defects, Das Company will send product to the buyer on its own and at its own expense. Repaired or replaced with faultless components of the product become the property of Das Company.
9. If removing defects is not possible, Das Company will replace the defective products with defects-free one at the dates indicated above.
10. This warranty is valid only for defects resulting from causes laying in the sold product and does not cover damage of the product occurred after the sale from other reasons, in particular, it does not apply if defects in the product arose as a result of:
 - a. the self-caused usage by the buyer, especially if the product has been used contrary to the instructions of usage provided by Das Company
 - b. if they are the consequence of normal usage and wearing of the goods or incorrect storage / transport by the buyer
 - c. mechanical, chemical or thermal damages
 - d. modifications, repairs, alterations or changes in the properties of the product made by the buyer
11. If the buyer is a consumer, exercising the terms of the warranty does not exclude, limit or suspend the ability to exercise warranty for defects of the goods. In relation to buyers who are entrepreneurs, according to the general conditions of contract available here http://dascompany.com/warunki_handlowe and <http://dascompany.com/regulamin>, statutory rights under the warranty for defects are excluded.
12. Das Company is not liable for damages resulting from inability to use the product send for repair, in particular, the buyer has no right to demand from Das Company claims for opportunity costs.
13. Das Company is not responsible for failure to observe the provisions of this warranty, in particular, failure to observe time limits specified in paragraphs 5-7, if they are the consequence of force majeure, the self-caused operation of the buyer or a third party, for which Das Company is not responsible or other circumstances unforeseen and independent on Das Company.
14. Das Company reserves the right to modify the terms of this warranty, however any changes in the warranty will not retroact.
15. Contact with guarantor: biuro@dascompany.com, phone: 500 248 480
16. The present warranty is valid from April 6-th, 2016







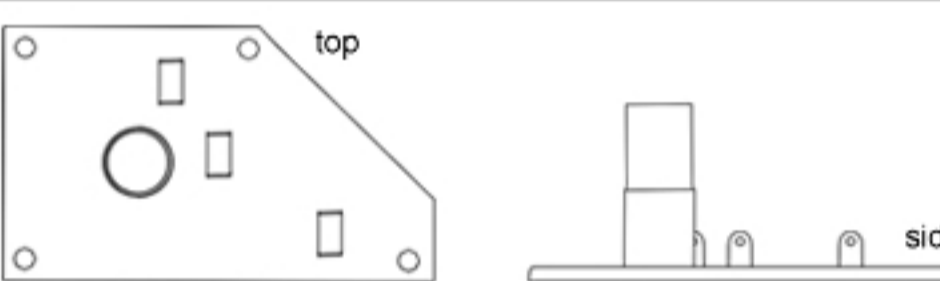
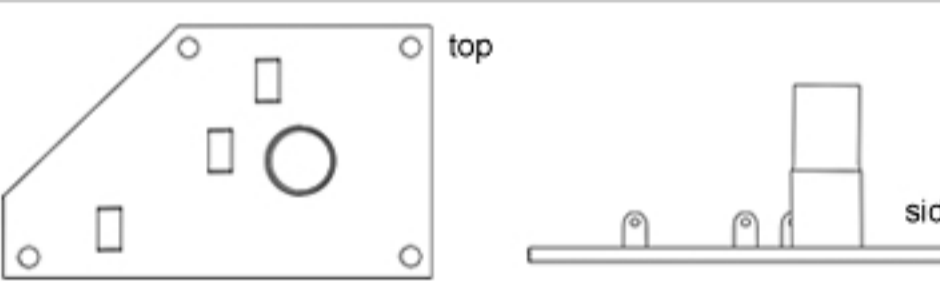









Terms of Use

1. In some countries you may need a building permit to assemble the tent.
2. The tent is only a temporary construction; it should not be used continuously.
3. The tent should be assembled in considerable distance from the pipelines, gas lines and electric wires.
4. Before the assembly, it should be made sure that the temperature outside is above 15 degrees Celsius. These conditions will prevent the cover from rupturing.
5. The tent should be assembled according to the manual.
6. The tent should be attached to the ground; all the holes in the feet should be used.
7. Only original parts should be used in the process of assembling the tent.
8. The tent should not be deployed during bad weather conditions, which include: a downpour, a strong wind or a snowfall.
9. In the case of any unfavourable weather conditions, the tent must be disassembled.
10. All the zippers must be fastened or opened entirely; it will prevent any damage to the cover. The zippers must not be half opened or half closed.
11. It should be made sure that the cover is strung accordingly. Such setting prevents water from gathering on the roof. Consequently, the tent will not be in danger of collapsing.
12. It should be noted that the water, if gathered on the roof, should be disposed of systematically.
13. During the winter, falling snow can be found gathering on the roof. It should be remembered that it must be kept off the tent; doing so prevents the tent from being damaged.
14. An adequate dilatation should be retained. It will allow gathered snow to fall off the tent.
15. The user of the tent is responsible for appropriate protection of the tent from any damage. The tent should be kept in such condition to prevent the users and the properties inside from any harm.
16. Open fire, the radiators with fire or the welding equipment should not be used in a proximity of the tent. Any other kinds of radiators can be used, but should not be put closer than a meter and a half from the cover.
17. The tent can be disassembled and packed only when it is dry; doing so prevents the formation of fungus.
18. The guarantee is valid only in the events which take place after the tent is assembled according to the manual and the terms of use.
19. The guarantee does not cover the wear of the consumables such as rubber or screws.
20. The guarantee does not cover the damage that is the result of negligence or incorrect use.
21. The tents with S38 (summer) and SP38 (summer plus) construction can be only used in the summer.
22. The tents using PE cover can be only used in the summer.
23. The tents with P50 (winter), PP50 (winter plus), polar and polar plus constructions can be also used in the winter.

Name	No.	Picture	10 x 8	10 x 12
Tube 78mm	1		24	32
Tube 78mm	1C		10	14
Roof/wall corner connector 78mm	2		10	14
Front/end connector 78mm	3		2	2
Middle connector 78mm	3A		3	5
Roof reinforcement 38mm	4		15	21
Roof and entrance reinforcement 38mm	5		14	18
Entrance reinforcement 78mm	6		4	4
Entrance reinforcement 78mm	7		4	4
Roof reinforcement 38mm	8		5	7
Horizontal entrance reinforcement 38mm	9C		4	4
Peak roof tube 50mm	10		4	6

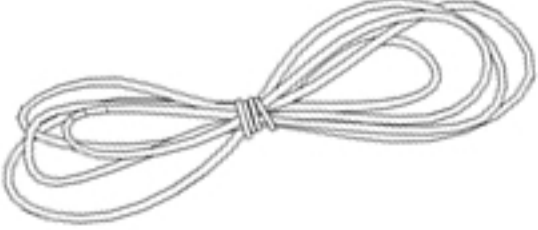
Name	No.	Picture	10 x 8	10 x 12
Cross roof tube 50mm	11		8	8
Cross roof tube 50mm	12		24	40
Wall reinforcement 38mm	13		4	4
Wall reinforcement 38mm	14		4	4
Bottom gate reinforcement 38mm	15A		4	4
Bottom gate reinforcement 38mm	16A		4	4
Tube coming through the roof tarpaulin	17		6	10
Tube coming through the roof tarpaulin	18		2	2
Tube coming through the entrance tarpaulin 25mm	19		8	8
Tube coming through the entrance tarpaulin 25mm	20		4	4
Left foot	A		2	2
Right root	B		2	2
Middle foot on the entrance	C		4	4
Middle foot on the sides	D		6	10

Name	No.	Picture	10 x 8	10 x 12
Screw M10x90			124	164
Screw M10x140			40	56
Screw M10x60			10	14
Screw M10x50			30	34
Screw M10x40			4	4
Screw M8x70			14	18
Screw M6x30			6	6
Rod			14	18
Single reel for the entrance			4	4
Double reel for the entrance			2	2
Buckle for the feet		 front  side	14	18
Belt			10	14
Strings 4 x 17m (entrance & roof) 4 x 7,6m (entrance & entrance frame) 6 x 5m (entrance & entrance frame reinforcement) 2 x 22,7m (gate lift)				
Ball with rubber (to fix the small entrance)			4	4
Plug			16	16

STEP 1

Distribute feet on leveled ground keeping distances as pictured.

10m x 8m

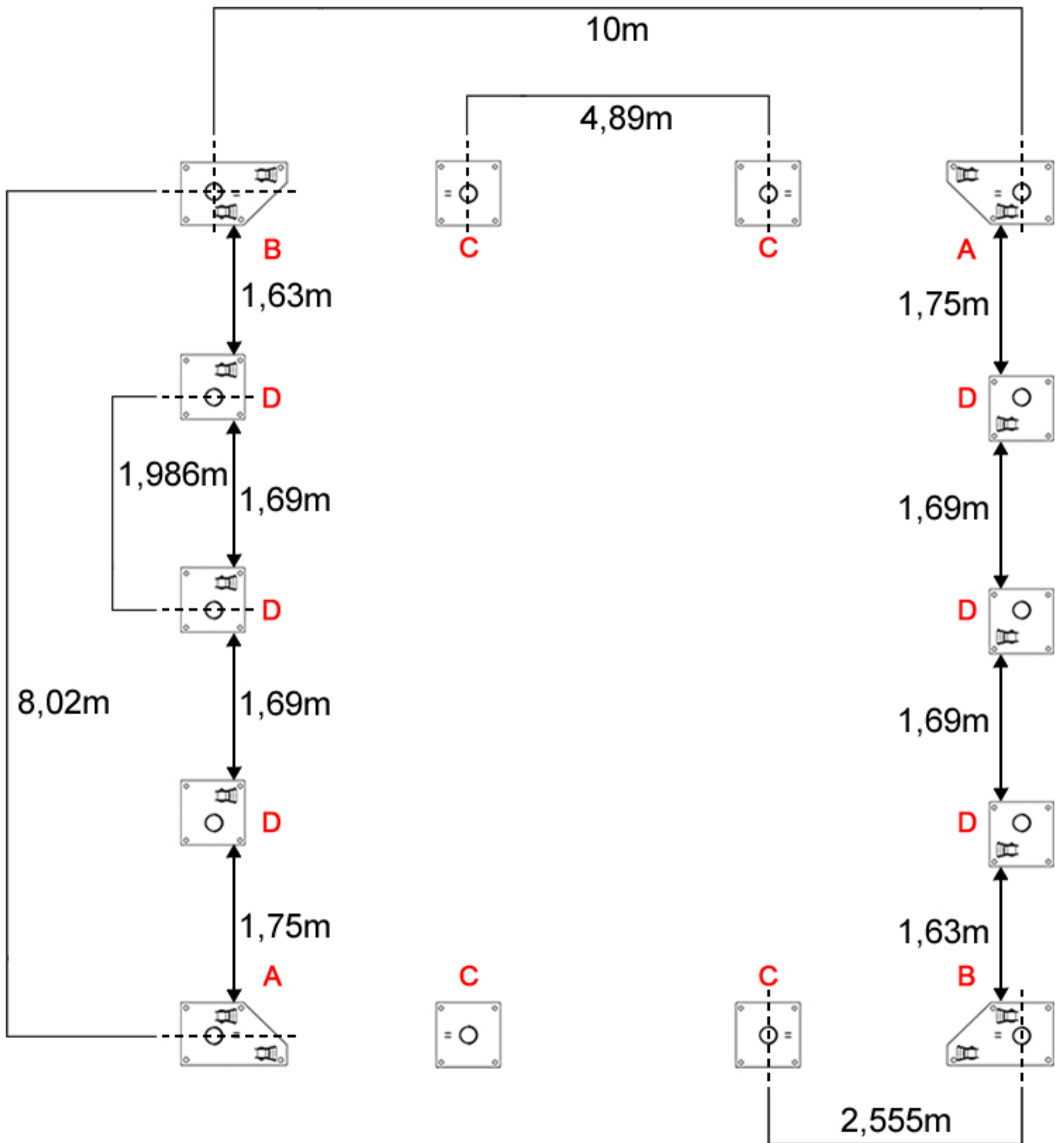

Distribute feet on leveled ground keeping distances as pictured.

10m x 12m

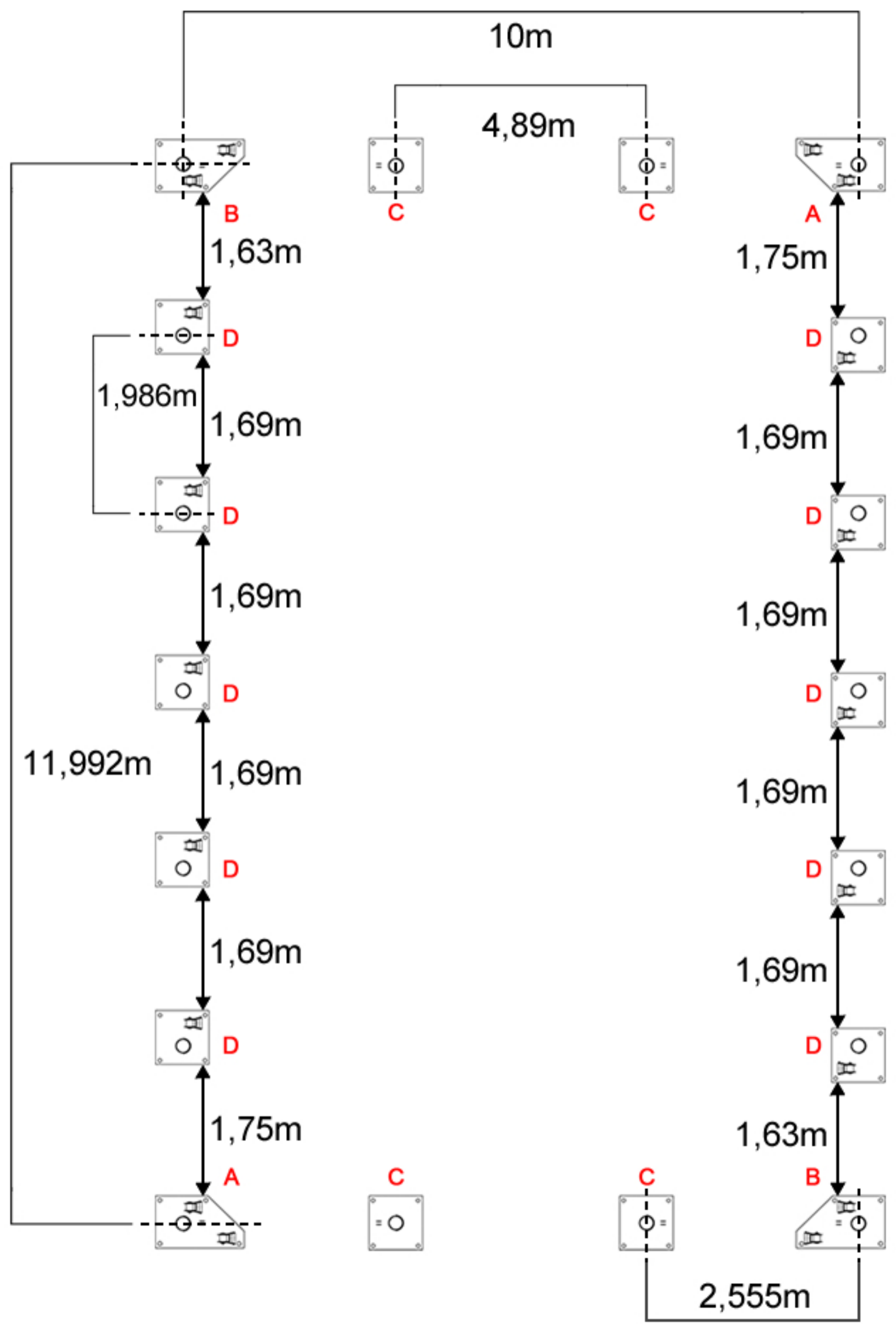

Distribute feet on leveled ground keeping distances as pictured.
 For the tents with length above 12m base constructions (10x8m or 10x12m) should be assembled first.
 Next, gently move one to the other as pictured.

10m x 16m

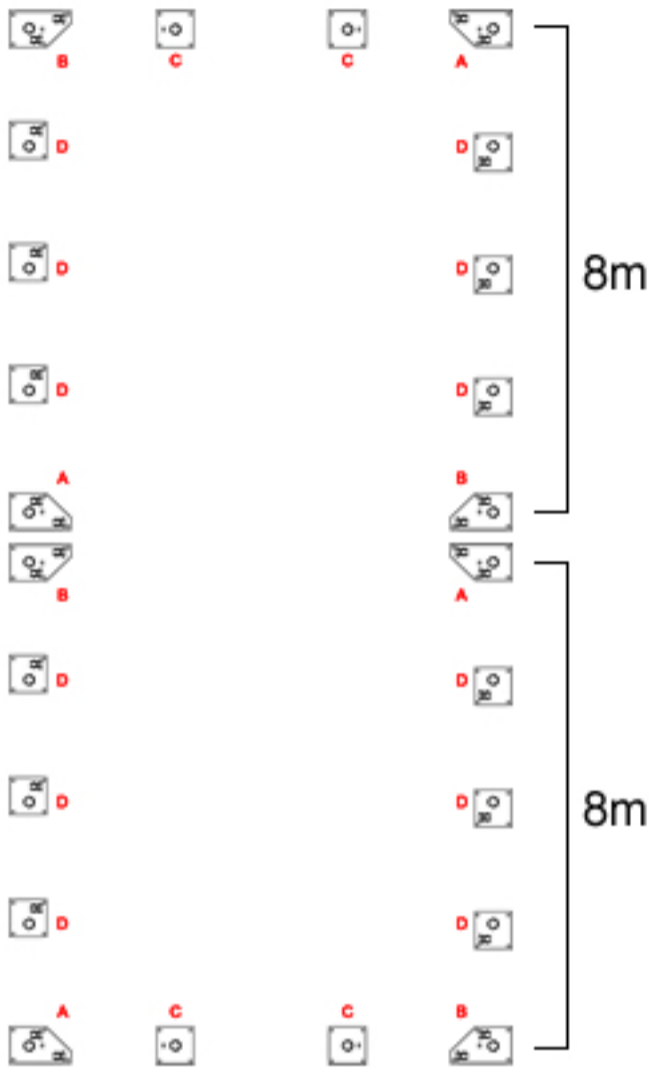

10m x 20m

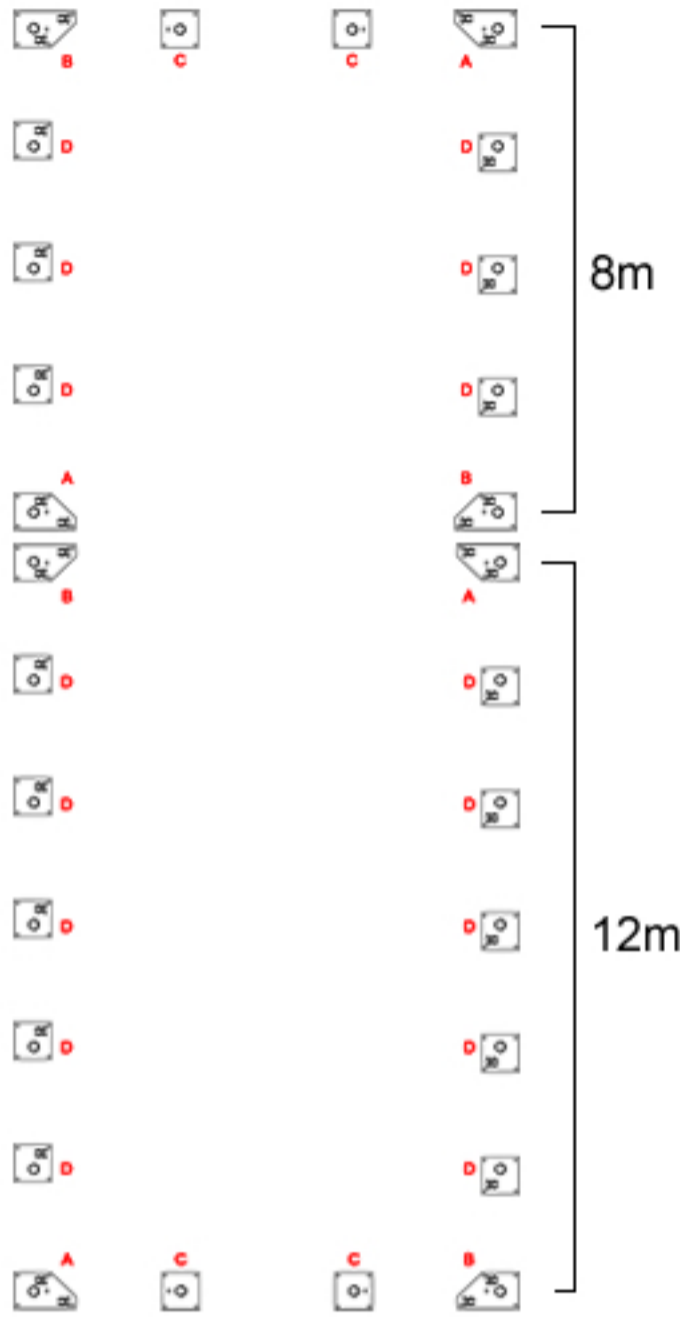

10m x 24m

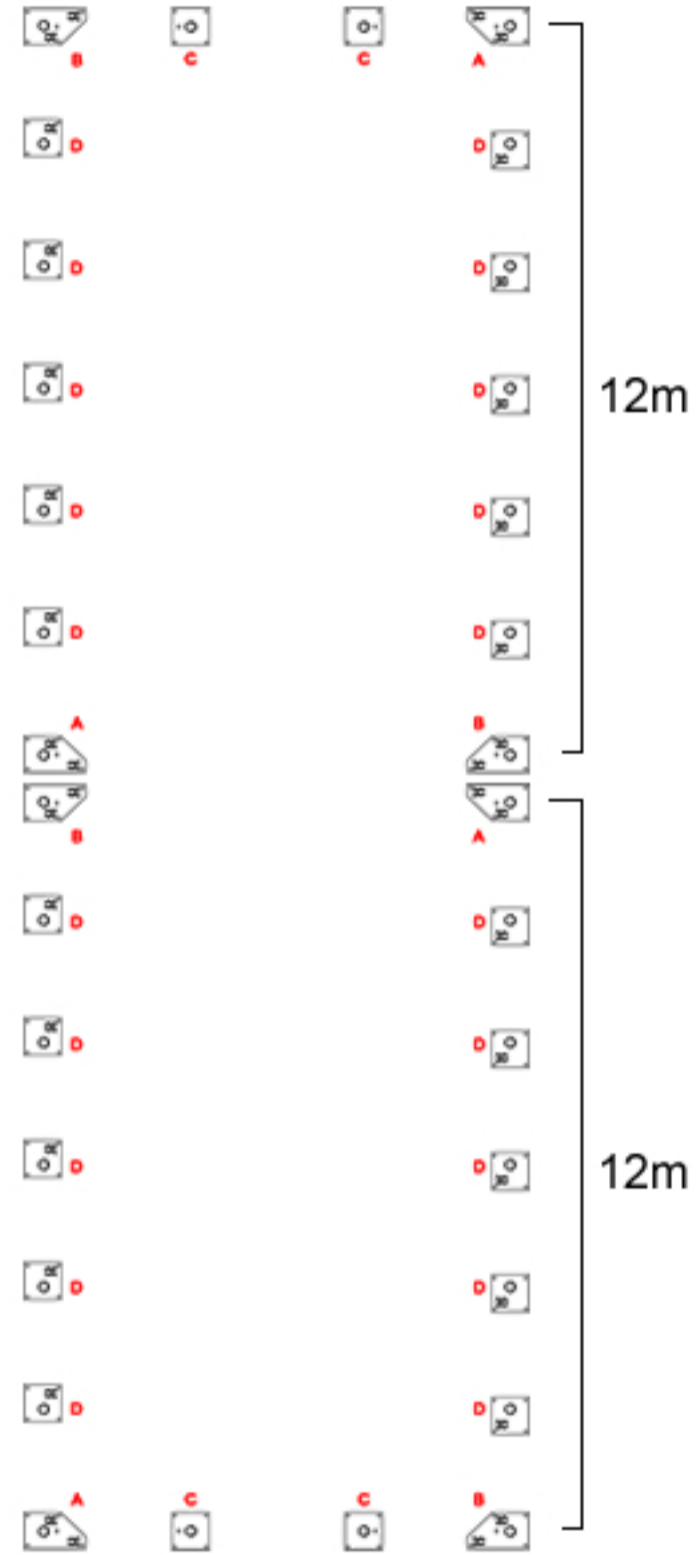

Distribute feet on leveled ground keeping distances as pictured.
For the tents with length above 12m base constructions (10x8m or 10x12m) should be assembled first.
Next, gently move one to the other as pictured.

10m x 28m



10m x 32m

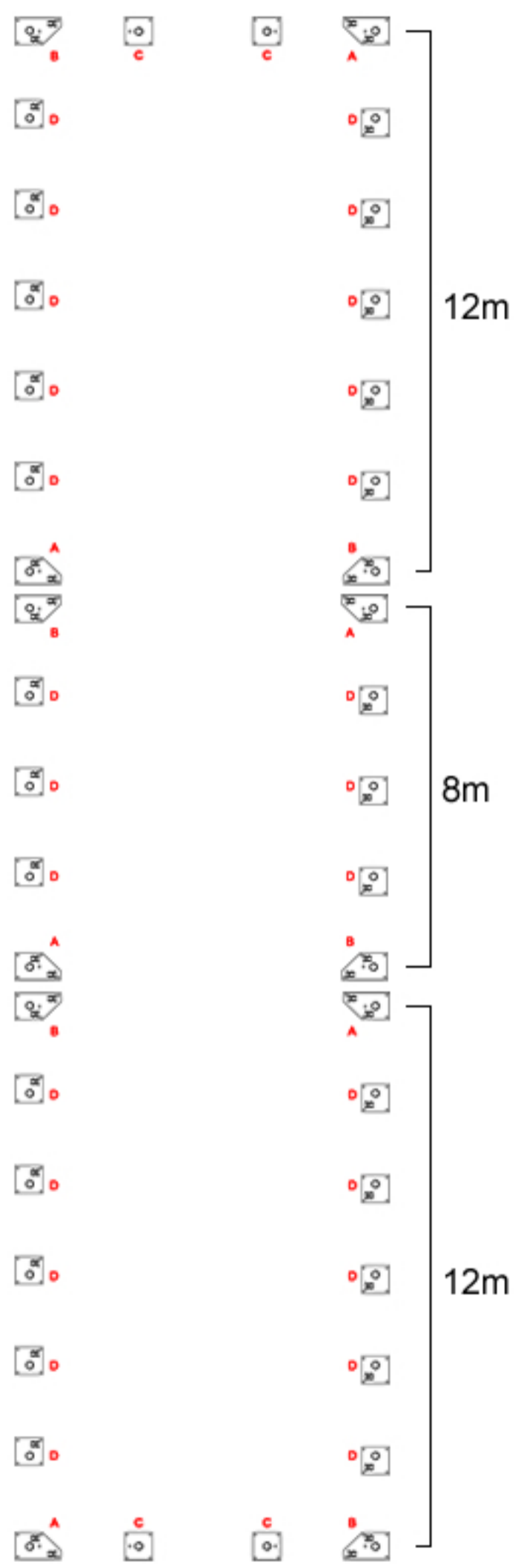

10m x 40m



Distribute feet on leveled ground keeping distances as pictured.

For the tents with length above 12m base constructions (10x8m or 10x12m) should be assembled first.

Next, gently move one to the other as pictured.

10m x 44m

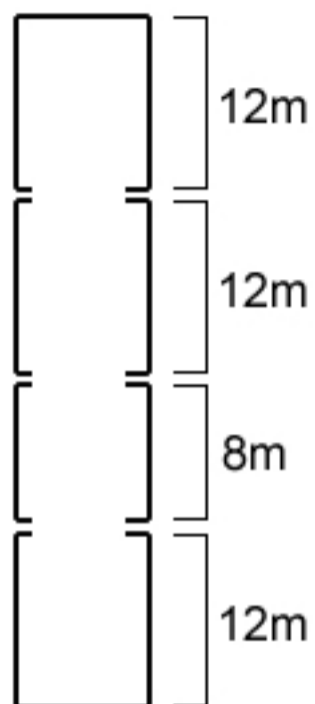

10m x 48m

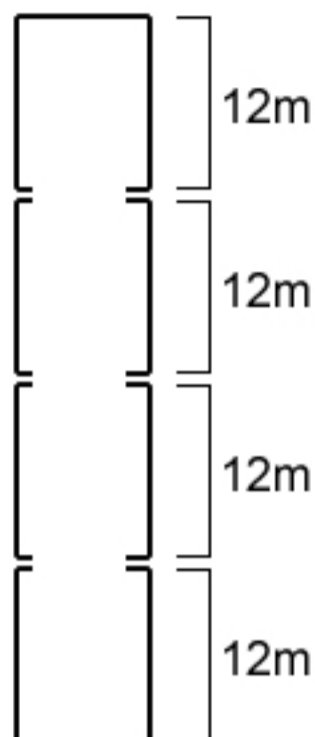

10m x 52m

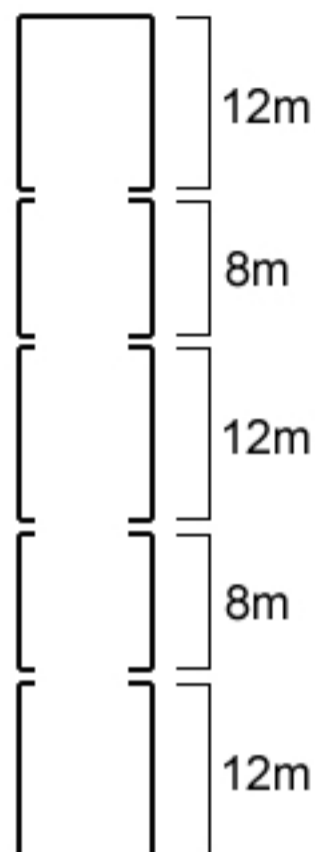

10m x 56m

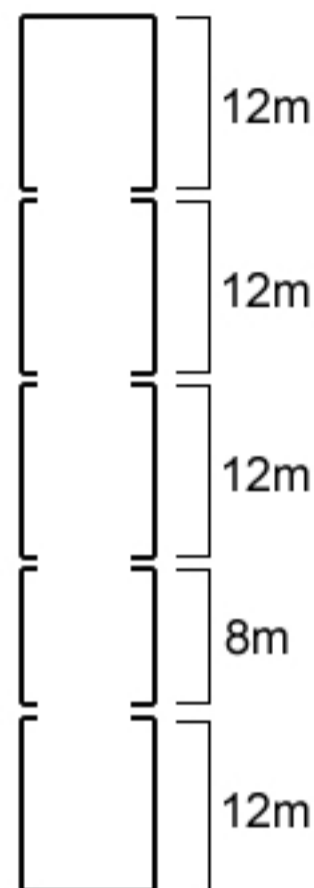

10m x 60m

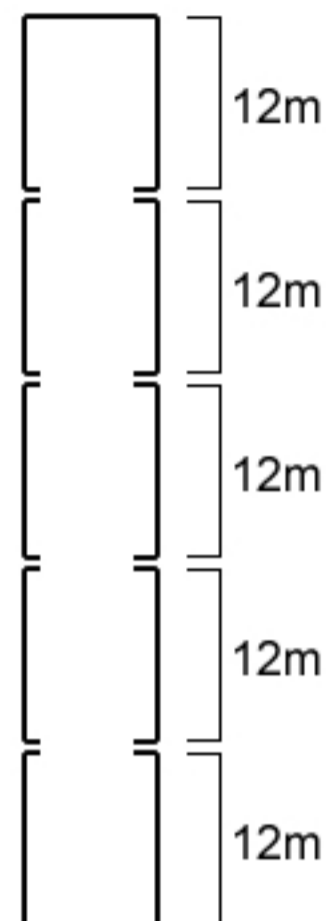

Fix the feet to the ground using the rods. The rods should criss-cross.

Manner in which tent is fixed to the ground should be regularly monitored in order to assure the security of the tent.

Attaching the tent to the ground correctly prolongs the durability of its components and the tent's construction as a whole.

Fix the buckle to the corresponding feet.

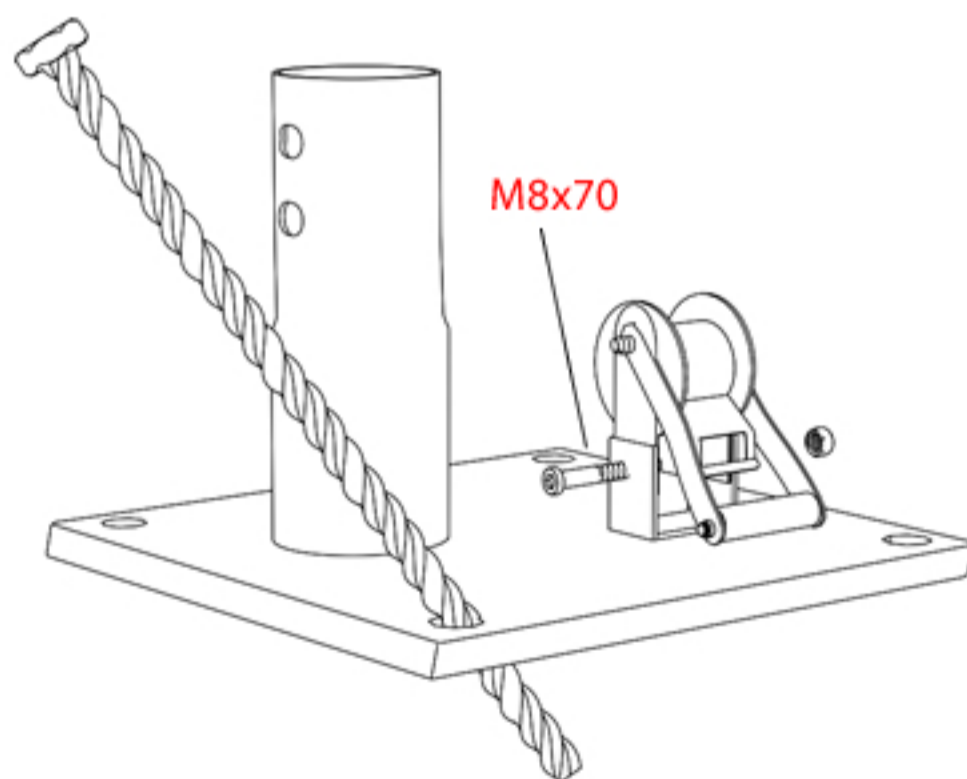

STEP 2

Connect tubes using the screws as shown on the picture. Make sure all the screws fit tightly.

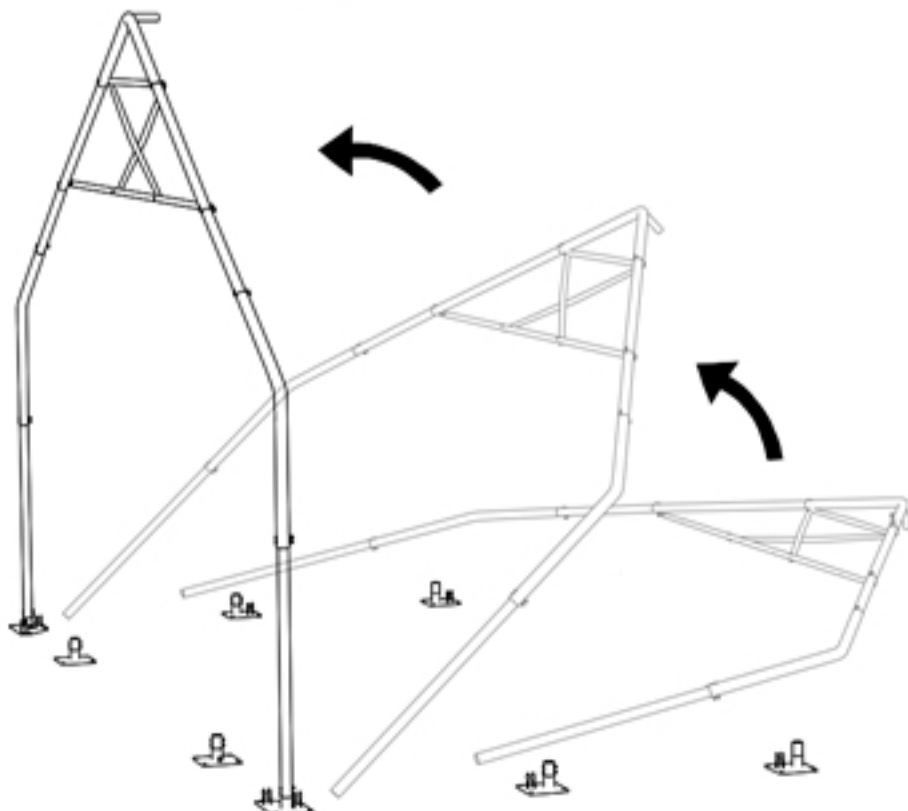
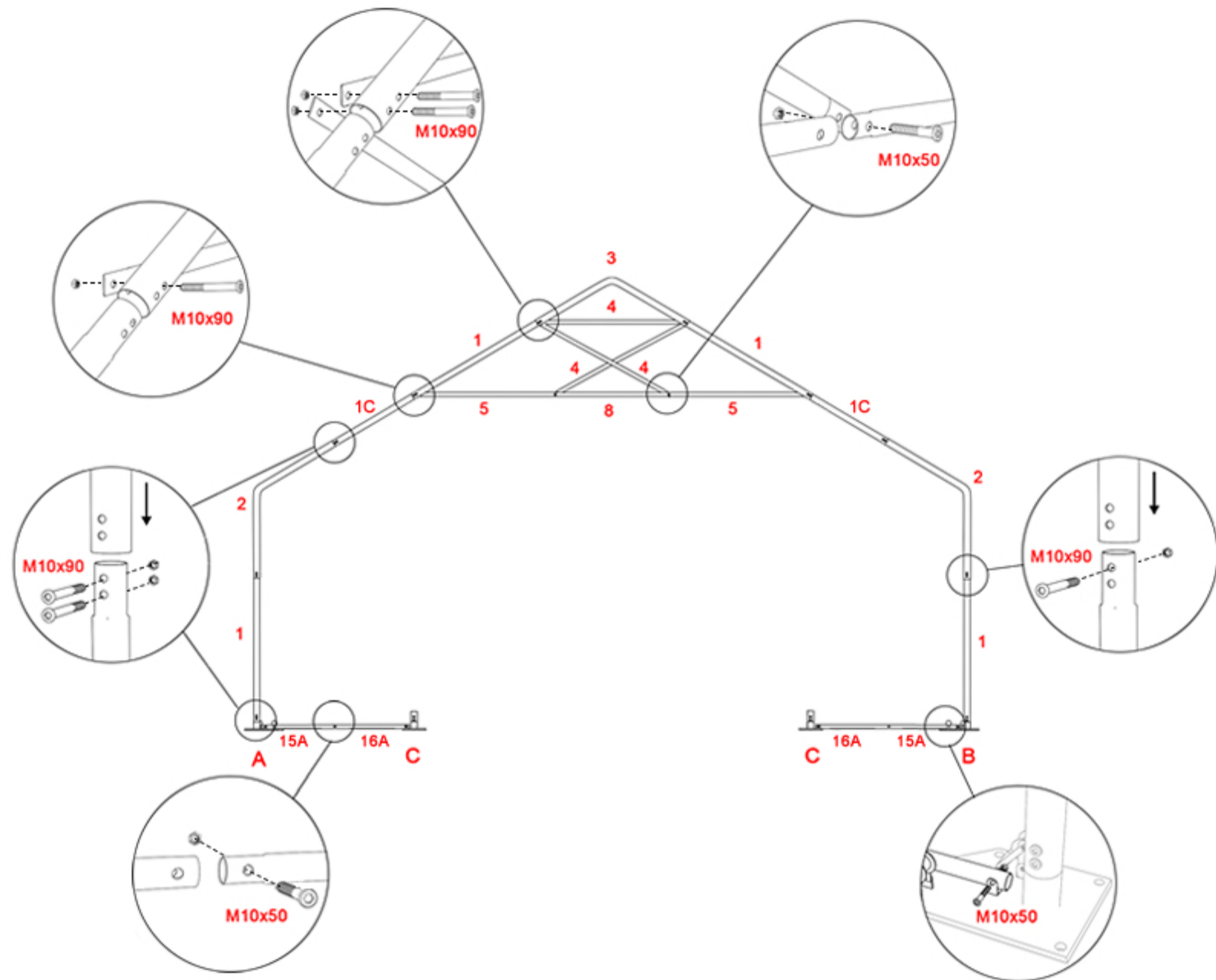
Front and back entrance

Assemble individual frames according to the pictures, fixing them after they are mounted to the feet.
Make sure every foot is fixed to the ground first.

STEP 3

Connect outer tubes and roof reinforcements using the screws.
Repeat for the following extensions.

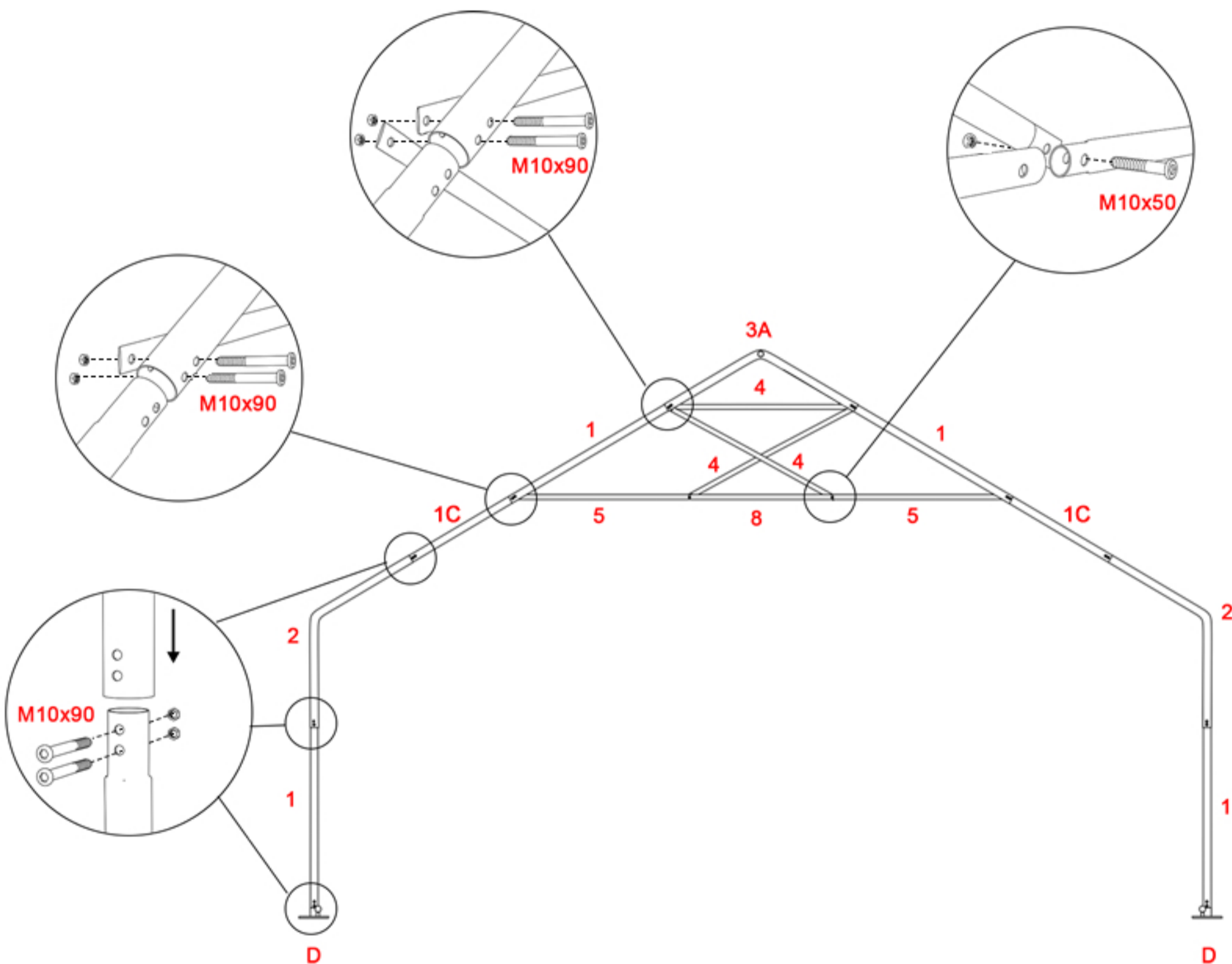
Inner frame

STEP 4

Connect all the frames using tubes.
Diagonal side wall reinforcement should be placed in the first and second panel.

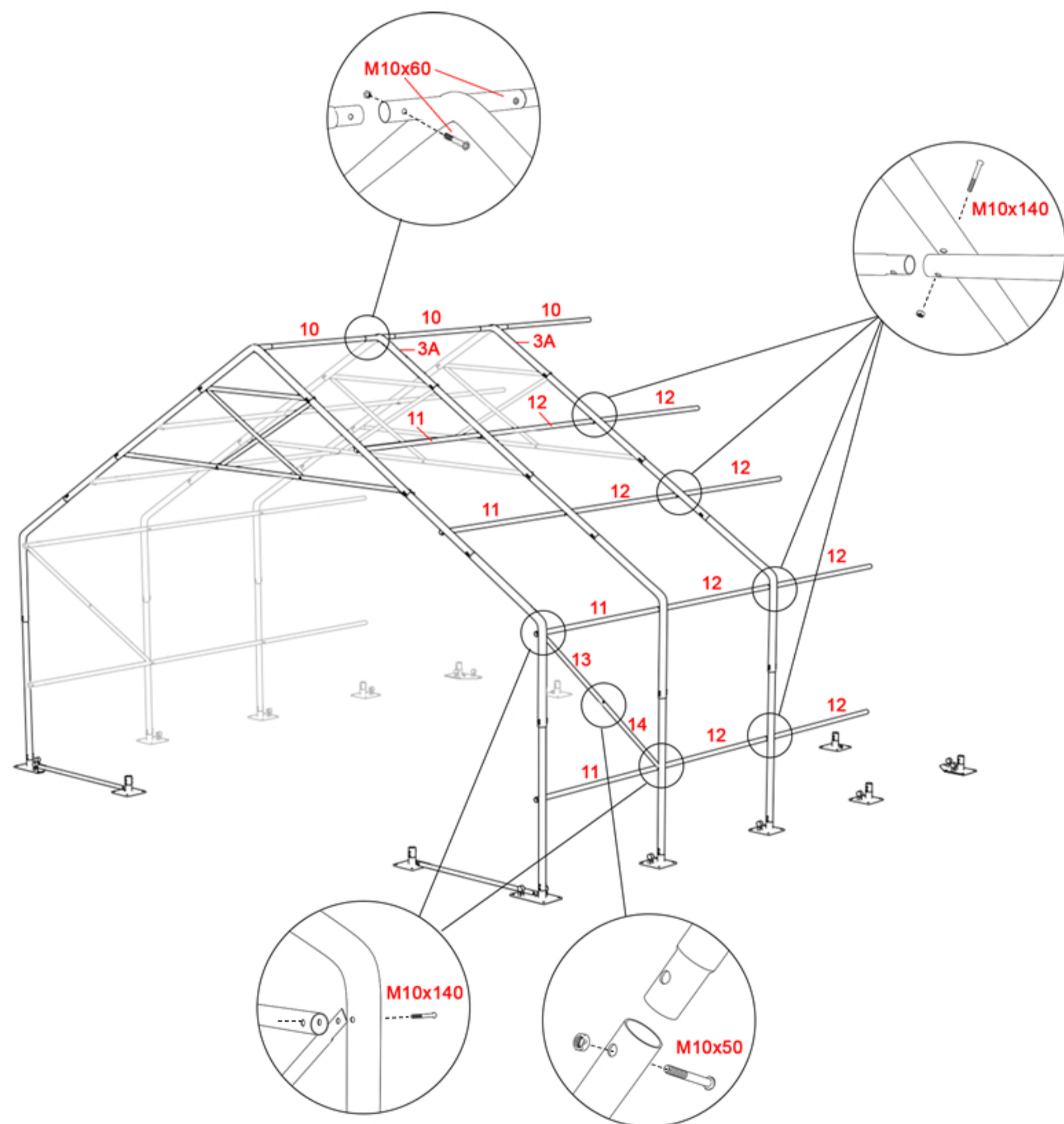

STEP 5

On the front and back frame mount entrance gate tubes. On the top tube fit reels (double reel on one side, one single reel in the middle and second on the other side)

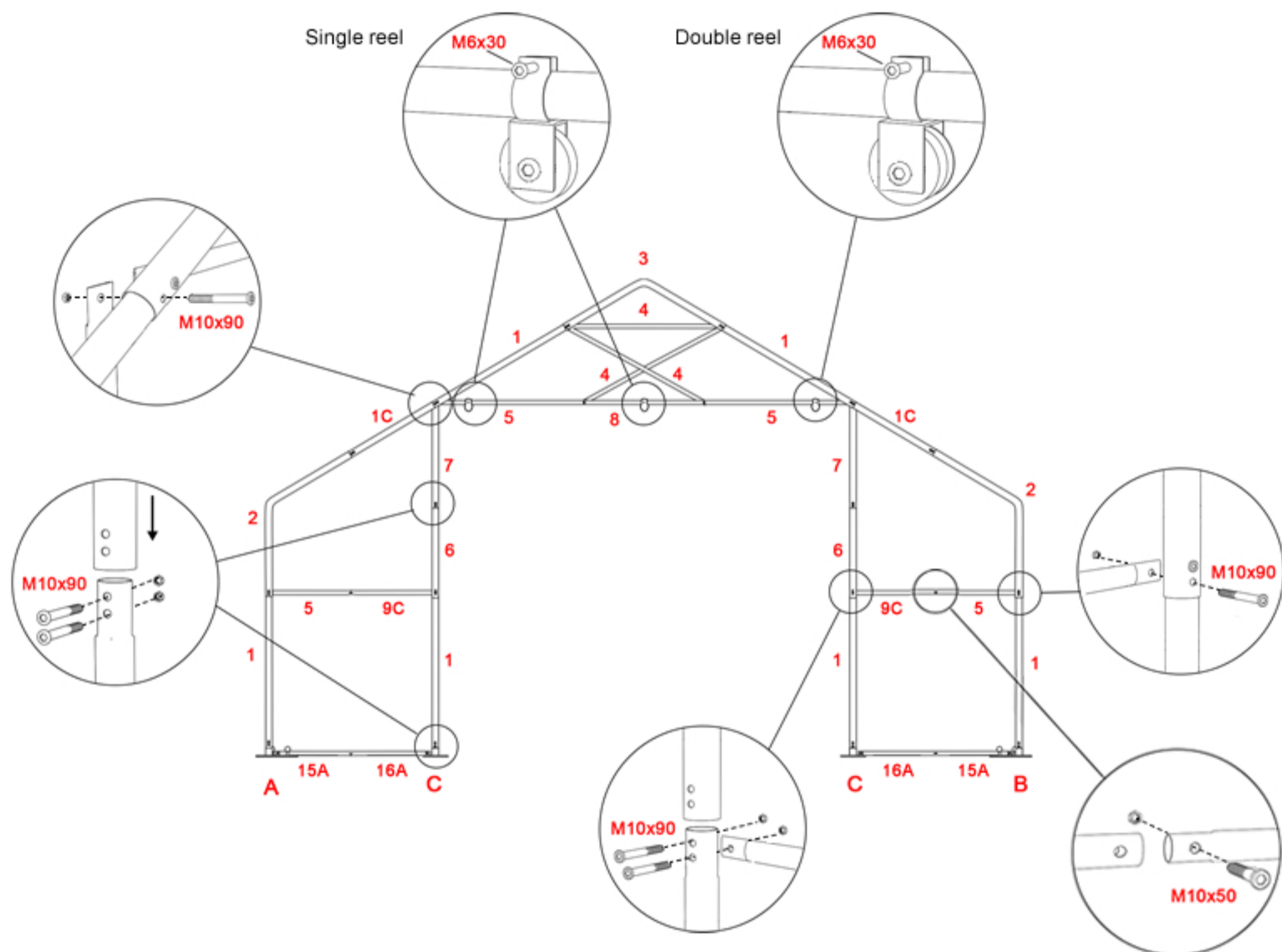

Przy konstrukcjach o długości powyżej 12m nie montujemy bramy wjazdowej między połączeniami głównych namiotów.

Assembled 10x8m construction

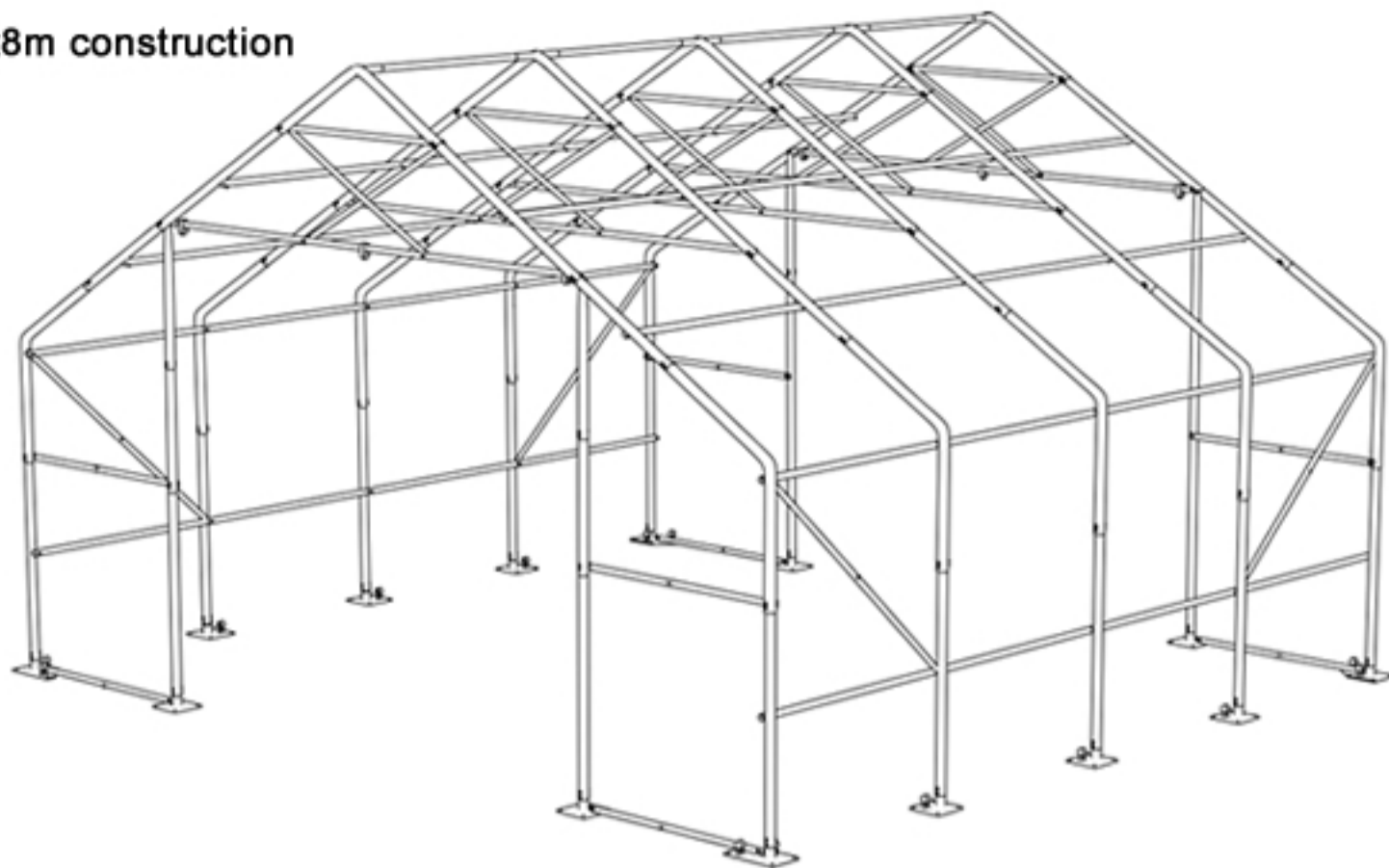

Assembled 10x12m construction

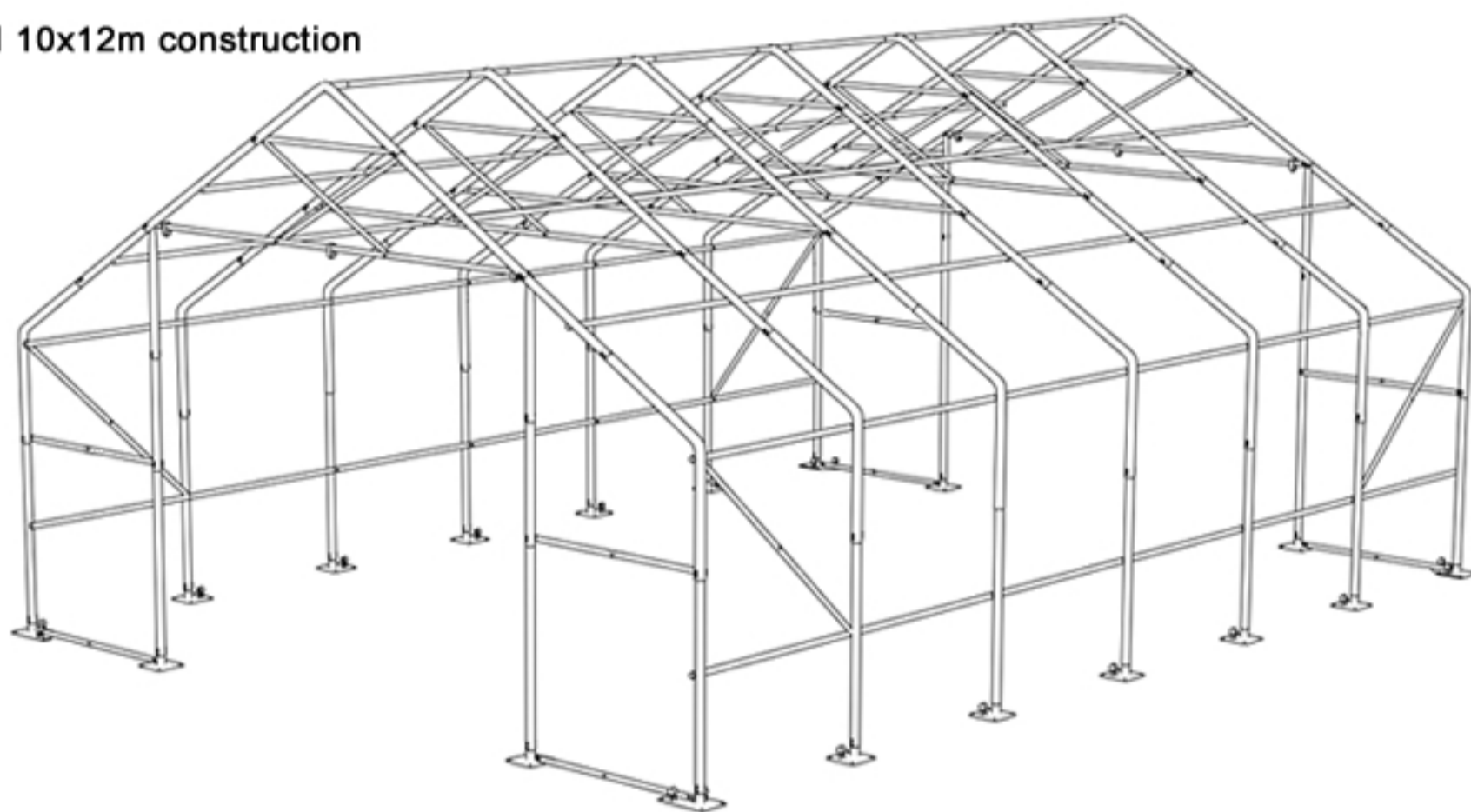

Assembled 10x16 construction (Two 10x8m constructions linked)

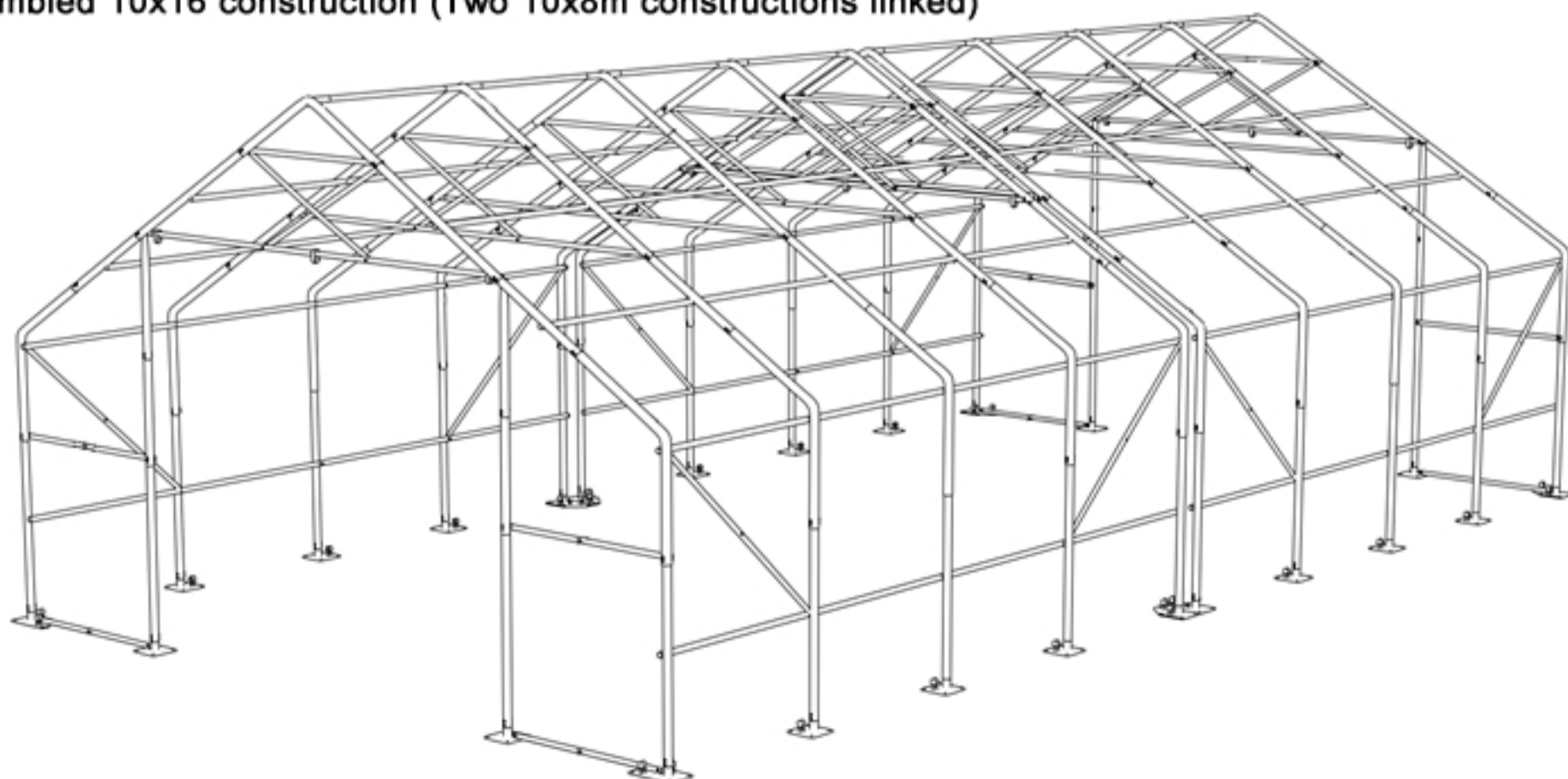

STEP 6

Distribute the tarpaulin along the wall of the tent. Transfer the tarpaulin through the whole length and width of the tent so it is possible to pull it to the pipes in the stitching using the lines. Make sure the tarpaulin is evenly distributed on each side. Remember that people on one side should pull and hold the tarpaulin so it can be easily moved on the steel construction on the other side.

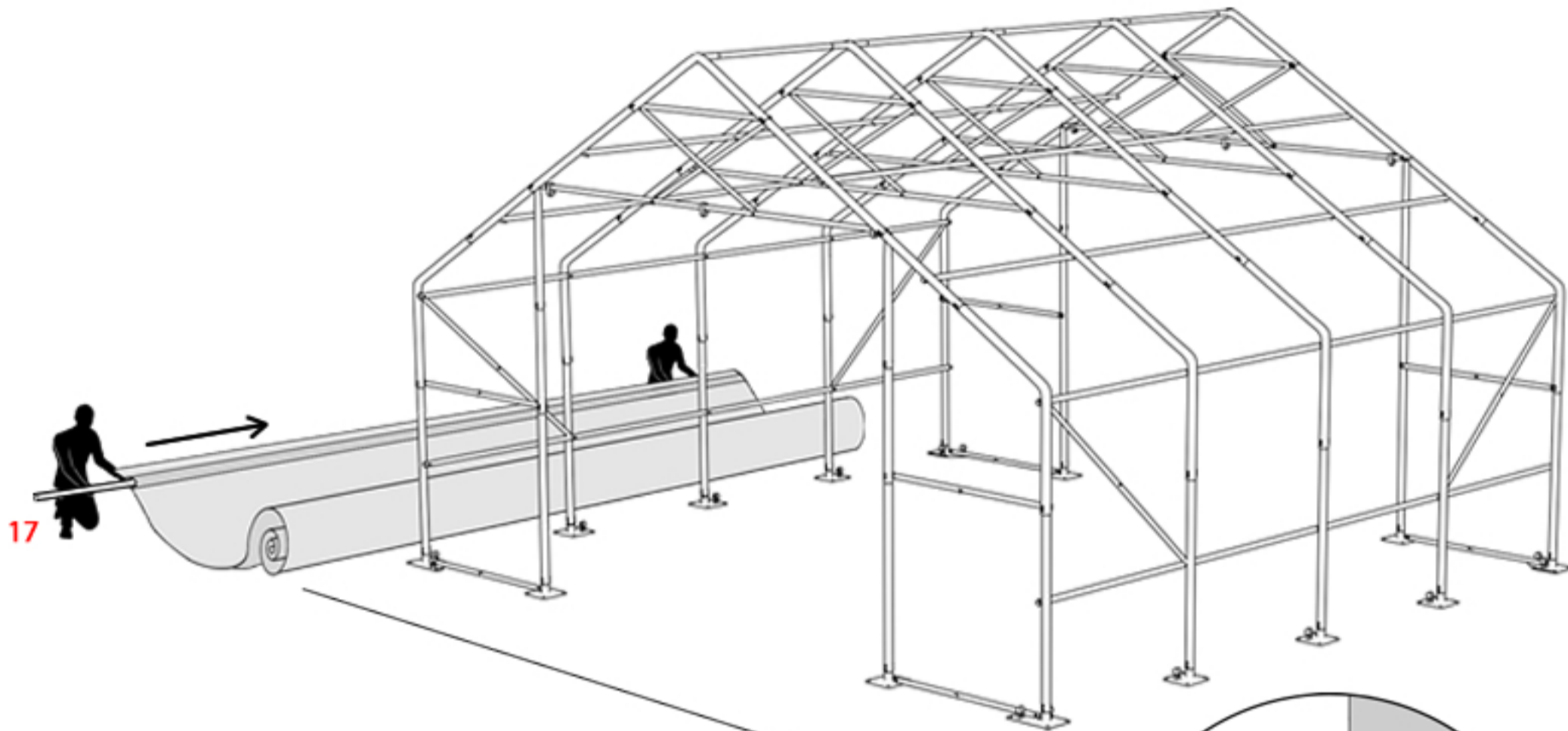

Before the distribution the tarpaulin should be stored in the temperature above 10 degrees Celsius. They should be distributed in such temperature (10 degrees Celsius or higher), otherwise it might crack on the bends.

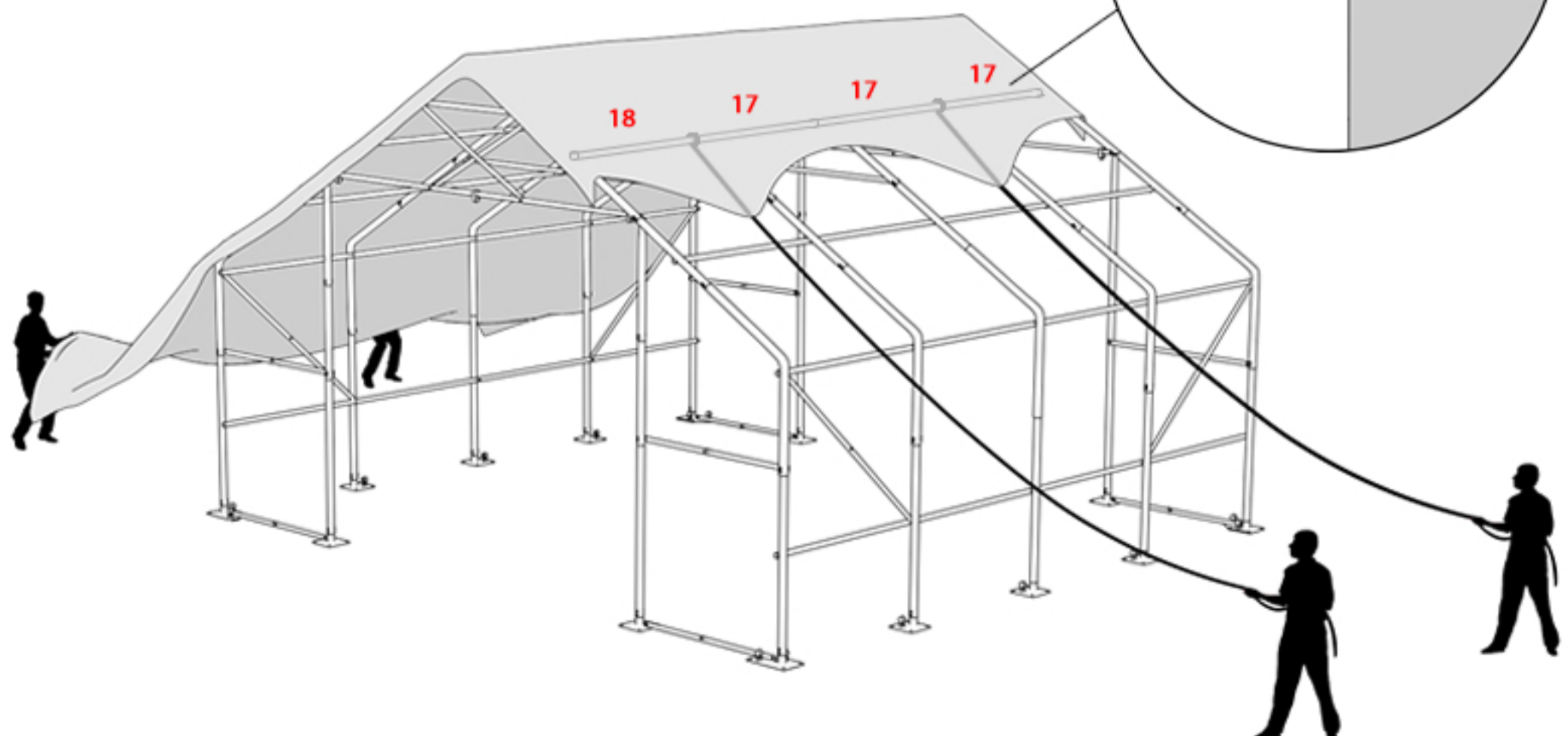
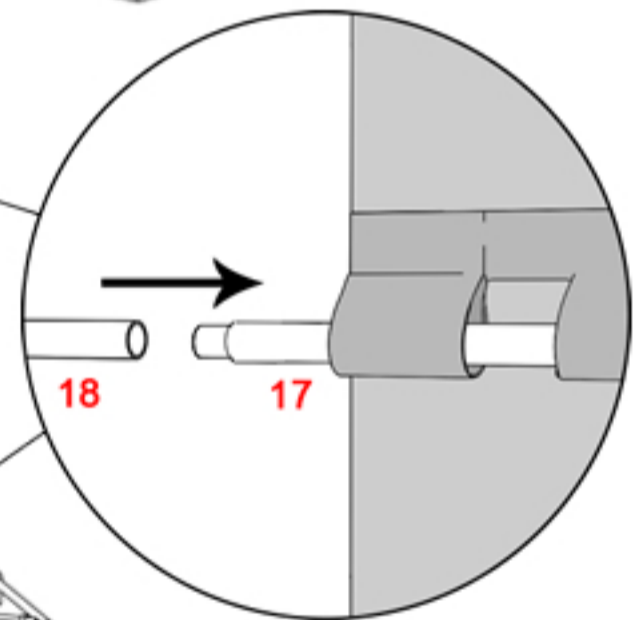

STEP 7

After the tarpaulin is in place, make sure all the pipes are placed in the stitching. Transfer belts through these tubes and pull on, hooking it on the buckle on the foot. Lock the buckle afterwards.

On the feet, transfer the belts through the tube and pull them, hooking them to the buckle located closer to the construction tube. Lock the buckle.

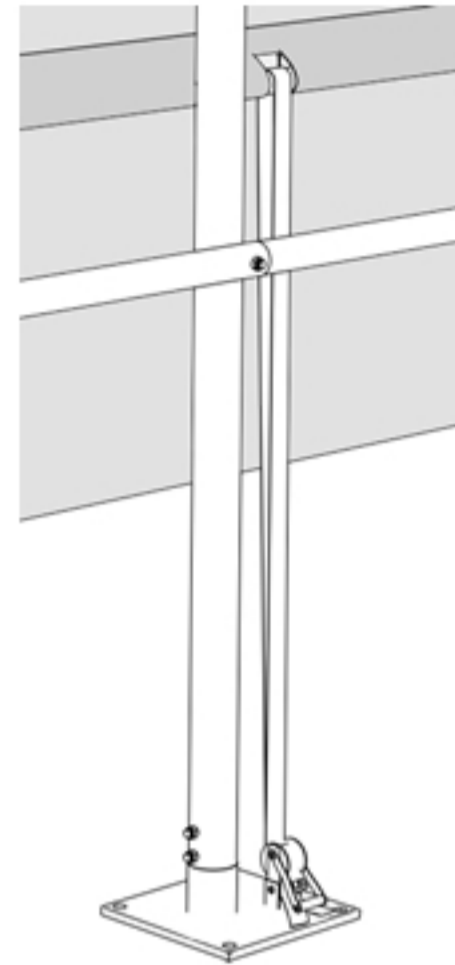

Fixed belt.

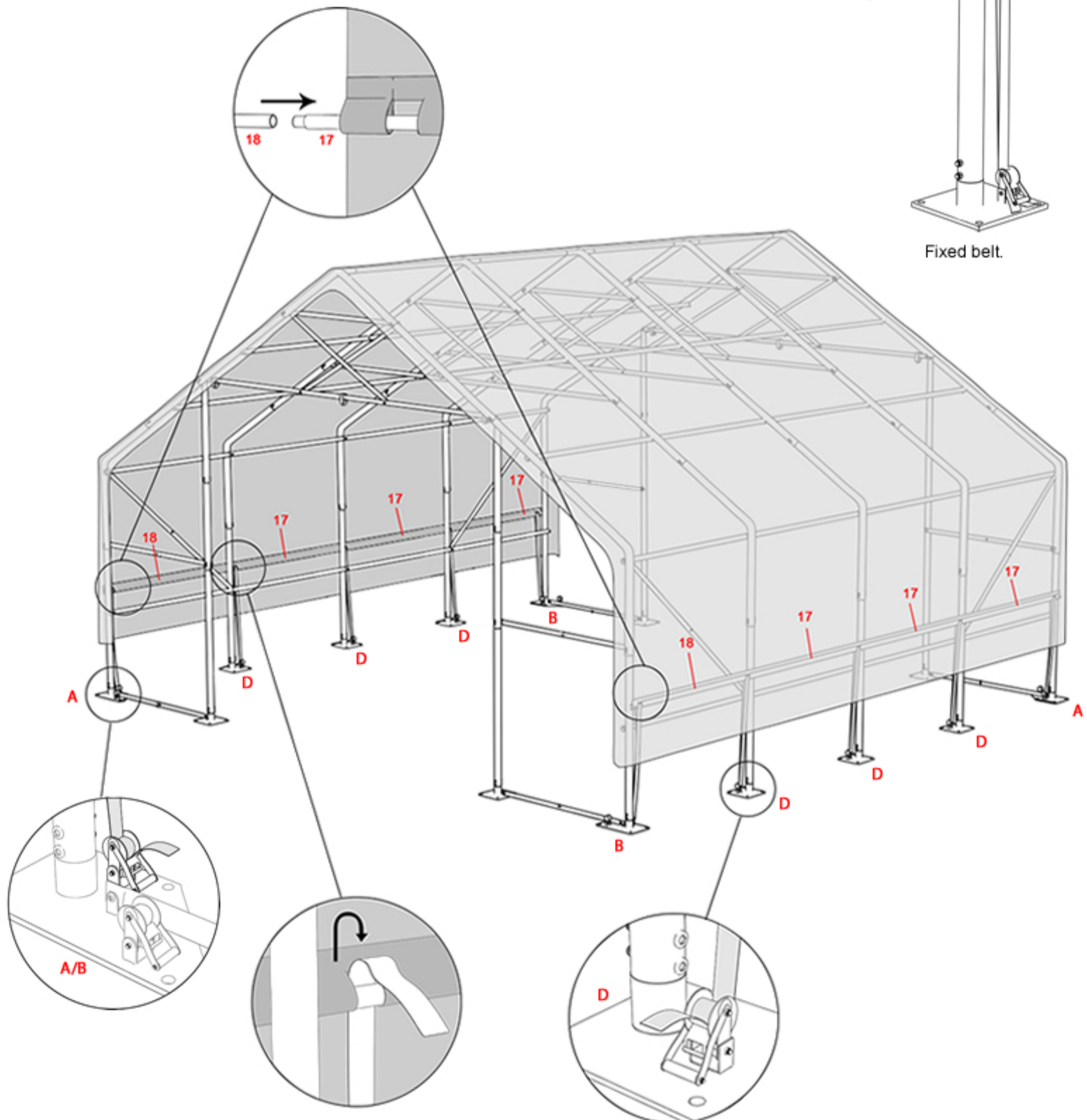

STEP 8

Pull the belt going through the tarpaulin on the entrances and hook it to the second buckle on the corner foot. Lock the buckle.

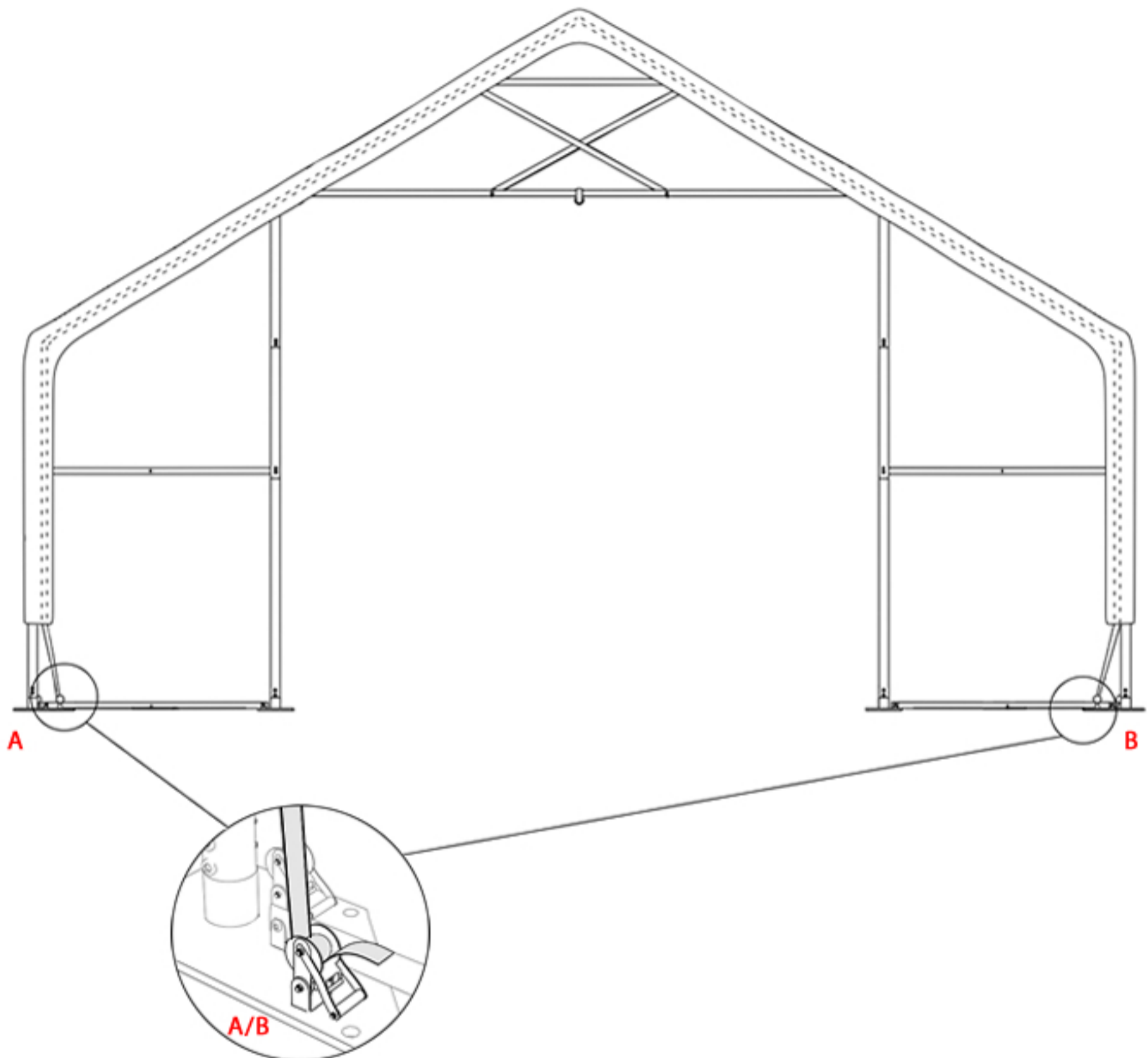

STEP 9

Fix tarpaulin extension on velcro.

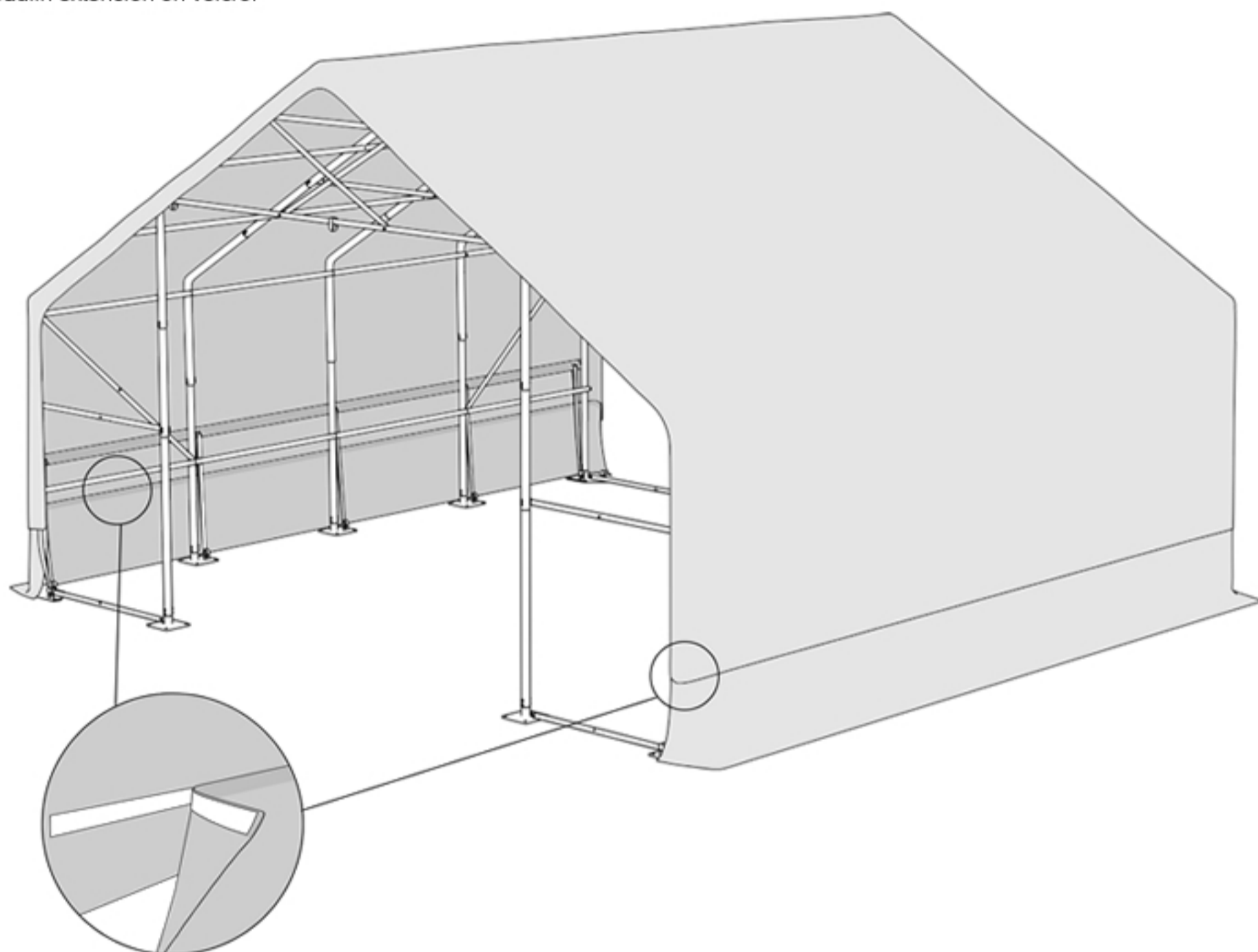

 For the tents longer than 12m

Fix the gutter connecting two tents to the tarpaulin using balls with rubber.

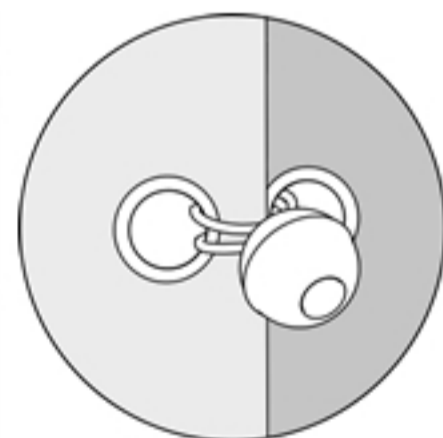
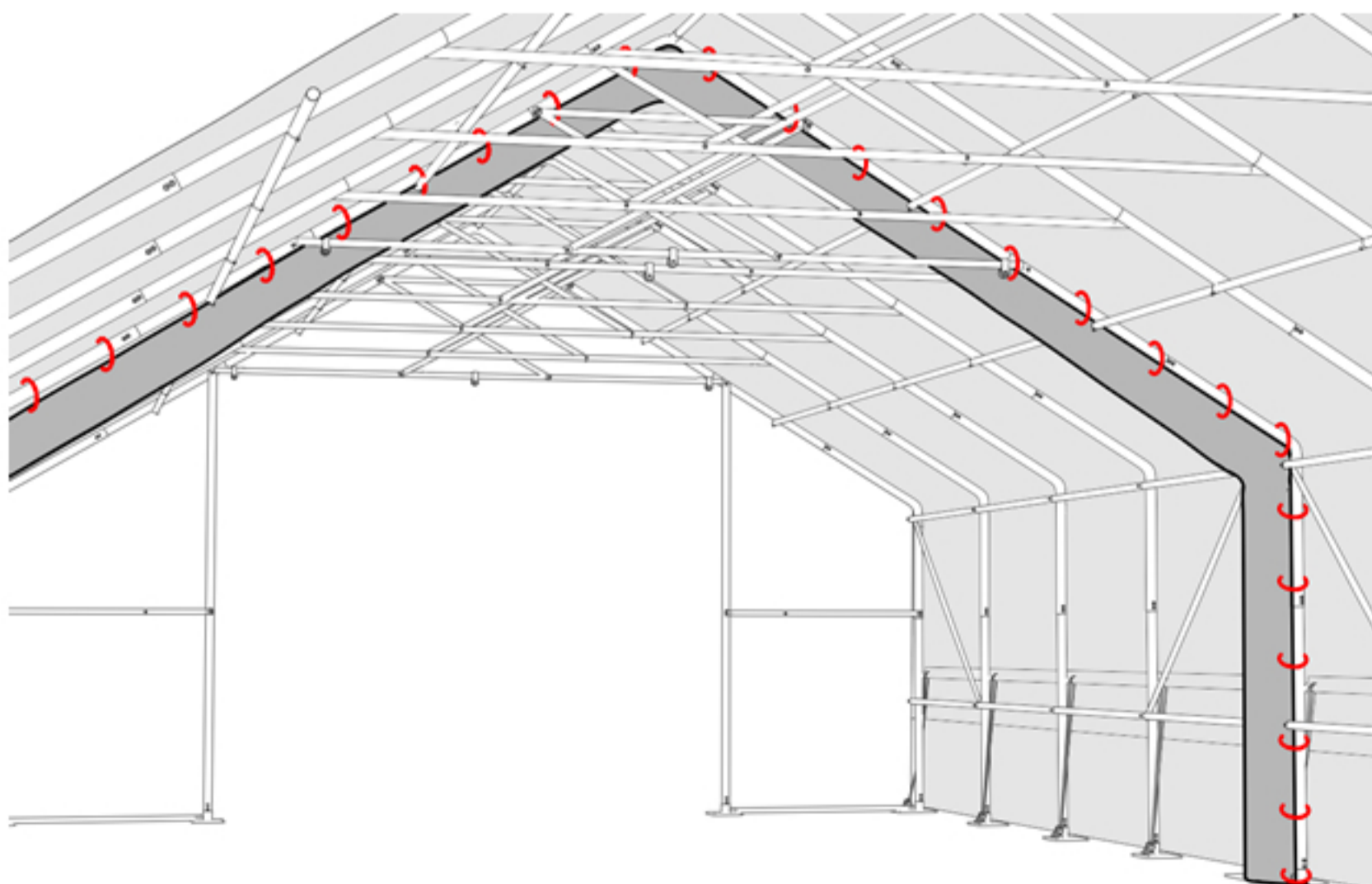

STEP 10**Entrance assembly**

Mount the entrance gate on the front and back frame. Pull on the front cover by wrapping string on the rods and transferring the string through the holes in the tarpaulin.

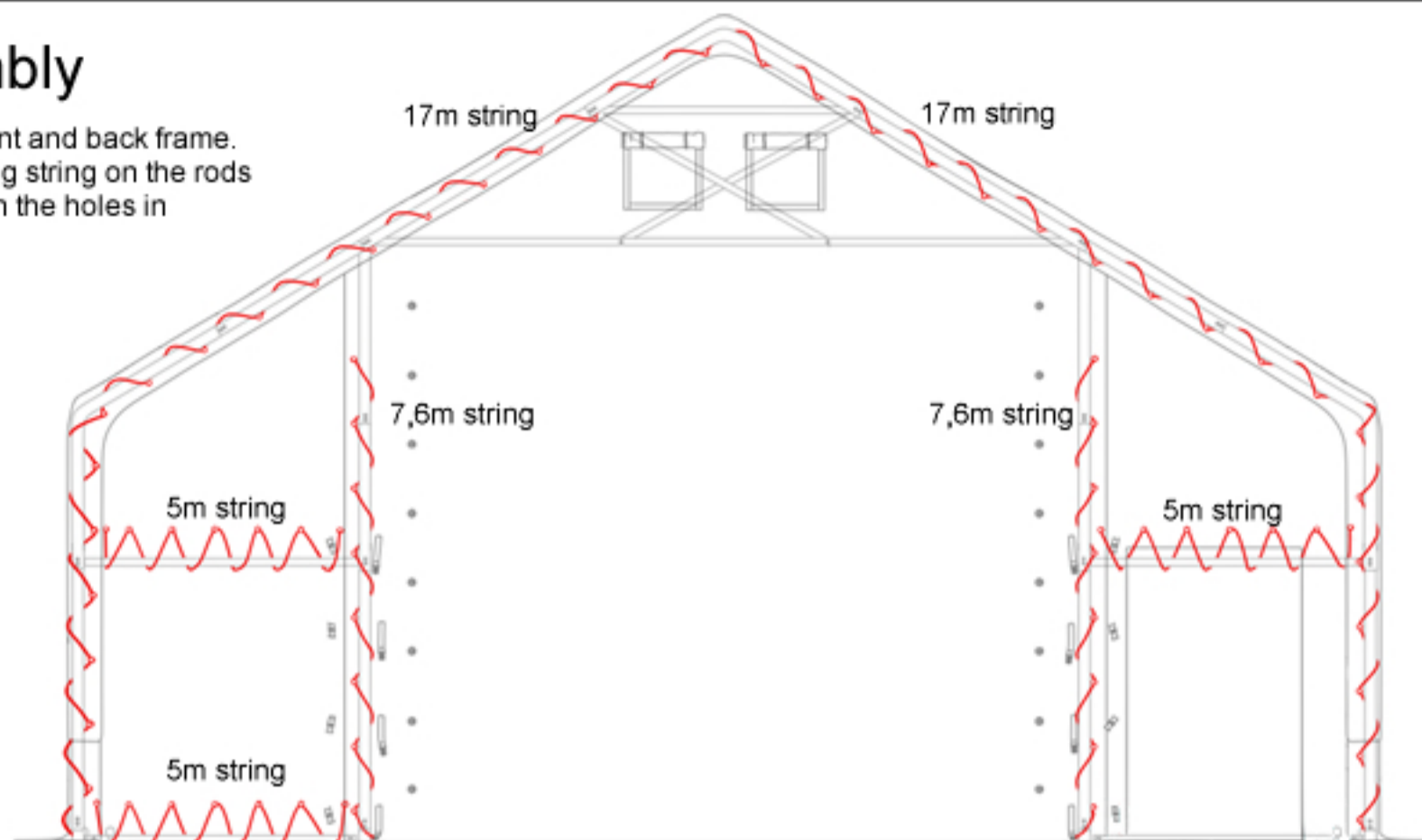
**STEP 11****Gate assembly**

Put tubes in the bottom pockets of the gate. Put 22m string in the gate holes on the left, under single reel (put the reel over the pipes). Pull the string through the reels along the gate to the double reel and again through the holes on the right side.

